

 **TRIO**
LIGHTING FOR YOU



OUTDOOR

2021

AUSSENLEUCHTEN
OUTDOOR LUMINAIRES

TRIO

LIGHTING FOR YOU



Sobald die Sonne untergeht, darf eine innovative Außenbeleuchtung nicht fehlen. Ein gut beleuchteter Außenbereich bietet nicht nur Sicherheit, sondern dient der Orientierung und schafft Atmosphäre rund um Ihr zu Hause. Außenleuchten sollten hohe Qualitätsanforderungen erfüllen, um den unterschiedlichen Bedingungen wie Feuchtigkeit, Regen, Schnee sowie jahreszeitlich bedingten Temperaturschwankungen unbeschadet standzuhalten. Unsere Außenleuchten werden in hochwertigem Aluminium-Druckguss gefertigt und versprechen Betriebssicherheit während der gesamten Lebensdauer, bei jeder Witterung, 365 Tage im Jahr. Moderne LED-Technologie sorgt darüber hinaus für gute Beleuchtungsqualität und hohe Energieeffizienz.

Wir wünschen Ihnen viel Freude mit unser neuen Outdoor-Kollektion.

As soon as the sun goes down innovative outside lighting is a must. Well lit outdoor areas do not only provide security, but are an orientation guide and create atmosphere around your home. Outdoor lighting should fulfil high quality standards to withstand diverse conditions such as dampness, rain, snow and seasonal variations in temperature. Our outdoor lamps are produced in high-quality diecast aluminium and promise operational reliability for their entire life cycle, in all weathers, 365 days a year. Modern LED technology also provides a high level of both light quality and power efficiency. We hope you enjoy our new outdoor collection.

Dès que le soleil se couche, un éclairage extérieur innovant est indispensable. Un espace extérieur bien éclairé offre non seulement la sécurité, mais vous aide aussi à vous orienter et crée une agréable ambiance autour de votre maison. Les luminaires extérieurs doivent répondre à des exigences de qualité élevées afin de résister sans dommage aux aléas climatiques telles que l'humidité, la pluie, la neige et les variations saisonnières de température. Nos luminaires d'extérieur sont fabriqués en aluminium moulé sous pression de haute qualité et garantissent une sécurité de fonctionnement pendant toute leur durée de vie, par tous les temps, 365 jours par an. La technologie LED moderne assure en outre une bonne qualité d'éclairage et une haute efficacité énergétique. Nous vous souhaitons beaucoup de satisfaction avec notre nouvelle collection d'extérieur.

Zodra de zon ondergaat, mag een innovatieve buitenverlichting niet ontbreken. Een goed verlichte buitenzone biedt niet alleen veiligheid, maar is goed voor de oriëntatie en scheidt sfeer rond uw huis. Buitenlichten moeten voldoen aan hoge kwaliteitsvereisten om bestand te zijn tegen diverse omstandigheden zoals vocht, regen, sneeuw alsook van het seizoen afhankende temperatuurschommelingen. Onze buitenlichten worden uit hoogwaardig aluminium gegoten en beloven een veilige werking tijdens hun volledige levensduur, bij alle weersomstandigheden, 365 dagen per jaar. Moderne ledtechnologie zorgt daarnaast voor een goede verlichtingskwaliteit en hoge energie-efficiëntie. We wensen u veel plezier met onze nieuwe collectie voor buiten.

Tan pronto como se pone el sol, no debe faltar una iluminación exterior innovadora. Una zona exterior bien iluminada no solo ofrece seguridad, sino que también sirve para orientarse y crear una atmósfera alrededor de tu casa. La iluminación exterior debe cumplir unos altos requisitos de calidad para soportar las diferentes condiciones de humedad, lluvia y nieve, así como las condiciones estacionales de oscilación de temperaturas. Nuestra iluminación exterior está fabricada en aluminio fundido a presión de alta calidad y aseguran la seguridad operativa durante toda su vida, en cualquier clima, 365 días al año. La moderna tecnología LED proporciona también una iluminación de buena calidad y una gran eficiencia energética. Le deseamos una gran satisfacción con nuestra nueva colección de exterior.

Non appena il sole tramonta, l'illuminazione esterna innovativa è un must. Un'area esterna ben illuminata non solo garantisce la sicurezza ma funge anche da mezzo di orientamento e crea una piacevole atmosfera intorno alla vostra casa. Le lampade per esterni devono soddisfare elevati requisiti in termini di qualità per resistere, senza subire danni, alle varie condizioni climatiche come umidità, pioggia, neve e fluttuazioni stagionali della temperatura. Le nostre lampade per esterni sono prodotte in alluminio pressofuso di alta qualità e garantiscono affidabilità operativa durante tutto il loro ciclo di vita, in qualsiasi condizione atmosferica, 365 giorni all'anno. La moderna tecnologia LED garantisce inoltre una buona qualità dell'illuminazione e un'elevata efficienza energetica. Vi auguriamo il massimo del piacere con la nostra nuova Collezione Outdoor.

De îndată ce soarele apune, un sistem inovator de iluminat exterior nu trebuie să lipsească. Un spațiu exterior bine iluminat nu oferă numai securitate, ci are și rolul de a asigura orientarea și de a crea o atmosferă plăcută în jurul casei. Lămpile exterioare trebuie să îndeplinească cerințe înalte de calitate, pentru a rezista fără deteriorări la acțiunea diferitelor condiții de mediu, precum umiditatea, ploaia, ninsoarea, precum și fluctuațiile sezoniere de temperatură. Lămpile noastre exterioare sunt produse din aluminiu turnat sub presiune și garantează siguranța în operare pe parcursul întregii durate de exploatare, în orice condiții meteo, timp de 365 de zile pe an. Tehnologia LED modernă asigură suplimentar o calitate bună a iluminatului și o eficiență energetică înaltă. Vă dorim să vă bucurați de colecția noastră outdoor.

Kun aurinko laskee, ei innovatiiviseen ulkovalaistukseen pitäisi tarvita puuttua. Hyvin valaistu ulkoalue tarjoaa turvallisuuden lisäksi myös kulkureittien ohjausta ja luo tunnelmaa kodin ympärille. Ulkovalaisimien on täytettävä korkeat laatuvaatimukset, jotta ne kestävät erilaisia olosuhteita, kuten kosteutta, sadetta, lunta ja vuodenaikojen lämpötilanvaihteluita ilman vaurioita. Ulkovalaisimet valmistetaan korkealaatuisesta painealletusta alumiinista, ja ne takaavat varman toiminnan koko käyttöikänsä ajan säästä riippumatta, 365 päivää vuodessa. Moderni LED-tekniikka varmistaa myös hyvän valaistuksen laadun ja korkean energiatehokkuuden. Toivomme, että uusi ulkovalaisinmallistomme tuottaa sinulle paljon iloa.

Gdy tylko zachodzi słońce, nie powinno zabraknąć innowacyjnego oświetlenia zewnętrznego. Dobrze oświetlone miejsce na zewnątrz nie tylko zapewnia bezpieczeństwo, ale także służy orientacji w terenie i tworzy atmosferę wokół domu. Oświetlenie zewnętrzne powinno spełniać wysokie wymagania jakościowe, aby bez uszkodzeń sprostać różnym warunkom, tj. wilgoć, deszcz, śnieg i sezonowe wahania temperatury. Nasze lampy zewnętrzne są produkowane z wysokiej jakości odlewane go aluminium i zapewniają niezawodność działania przez cały okres użytkowania, bez względu na pogodę, 365 dni w roku. Nowoczesna technologia LED zapewnia również dobrą jakość oświetlenia i wysoką efektywność energetyczną. Życzymy Państwu wiele radości z korzystania z naszej nowej kolekcji oświetlenia zewnętrznego.



Serienübersicht · Family overview

Aperçu par famille · Overzicht per familie · Vista general por familia · Panoramica per famiglia ·
Prezentare pe familii de produse · Perheen yleiskuvas · Przegląd rodziny



ADAJA	62	NORMAN	108	ARACATI	152
AMUR	107	OHIO	67	ARBIETO	191
ARKANSAS	135	OLONA	134	ARUBA	168
BELAJA	140	PADMA	75	BAHAMAS	172
BREG	86	PEARL	36	BARBADOS	172
BRENTA	130	PECOS	82	BERMUDA	166
CANNING	112	PEDRO	87	BOGOTA	156
COLORADO	54	PIAVE	88	BOLO	176
COOPER	110	RENO	20	CALDERA	196
CUANDO	70	RHINE	24	CAMARO	160
CUBANGO	102	ROYA	50	CAMIRI	192
DONEZ	104	SACRAMENTO	64	CARMELO	194
DUERO	137	SAMBESI	120	CORDOBA	154
EBRO	32	SEINE	48	CORO	195
FUERTE	14	SHANNON	30	COTOCA	193
GAMBIA	34	SUEZ	26	DOMINGO	174
GANGES	22	TANARO	126	DORA	173
GARONNE	114	TAWA	55	ESQUEL	182
GRACHT	136	TAY	61	FOMOSA	184
HARDEY	139	THAMES	56	HAITI	169
HARLEM	66	THAMES II	58	HAWAII	170
HONDO	85	TIBER	74	JAMAICA	167
HOOSIC	92	TICINO	28	KENDAL	158
HORTON	44	TIMOK	84	LENNON	175
HUDSON	98	TRAVE	68	LOJA	197
INDUS	71	TRENT	60	LORA	173
KASAI	83	TUNGA	76	MELO	198
KATUN	18	UBANGI	145	MENDOZA	184
KAVERI	52	YANGTZE	72	MINAS	194
KELLY	138			MINEROS	186
KONDA	65			MOLINA	157
KONGO	106			MONTERO	190
LOGONE	16			PALMAS	164
MITCHEL	12			PARRAL	196
MUGA	80			POSADAS	180
MURRAY	90			ROSARIO	155
NECTOR	142			SALTA	185
NELSON	40			VINTO	188

Produktübersicht · Product Overview

Aperçu des produits · Productoverzicht · Descripción del producto ·

Panoramica prodotto · Vizualizare produs · Tuotteen yleiskuvaus · Przegląd produktów



FUERTE
14



SUEZ
26



RHINE
24



EBRO
32



TICINO
28



SHANNON
30



MITCHELL
12



NELSON
42



GANGES
22



PEARL
38



SEINE
48



TAWA
55



HARLEM
66



CUANDO
70



HORTON
46



TRAVE
68



THAMES
56



THAMES II
58



TRENT
60



LOGONE
16



COLORADO
54



TAY
61



SACRAMENTO
64



PADMA
75



KATUN
18



RENO
20



COOPER
110



ROYA
50



TIBER
74



KAVERI
52



ADAJA
62



BOGOTA
156



CORDOBA
154



ROSARIO
155



ARACATI
152



ARACATI
152



HOOSIC
92



HOOSIC
96



HUDSON
98



HUDSON
100



MOLINA
157



MOLINA
157



YANGTZE
72



INDUS
71



TIMOK
84

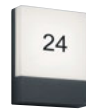

PECOS
82



MUGA
80



PEDRO
87



KONDA
65



KENDAL
158



HONDO
85



TRAVE
69



BREG
86



KENDAL
158



CAMARO
160



MURRAY
90



DONEZ
104



AMUR
107



CUBANGO
102



KONGO
106



CANNING
112



GARONNE
114



GARONNE
116



SAMBESI
122



TANARO
128



ARKANSAS
135



GRACHT
136



OLONA
134



DUERO
137



BRENTA
130



BRENTA
132



MITCHELL
12



FUERTE
14



RHINE
24



SUEZ
26



TICINO
28



PEARL
38



ROYA
50



NELSON
42



HORTON
46

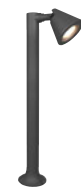

KAVERI
52



SEINE
48



LOGONE
16



GANGES
22



RENO
20



KATUN
18



COOPER
110



KONGO
106



SHANNON
30



EBRO
32



HOOSIC
96



HUDSON
98



CANNING
112



GARONNE
114



SAMBESI
122



TANARO
128



DONEZ
104



CUBANGO
102

Sicherheit & Komfort / Sensorleuchten · Security & Comfort / Sensor Lights

Sécurité et confort / Lampes à détecteur · Veiligheid en comfort/sensorlampen · Seguridad & Comodidad / Luces del sensor ·
Sicurezza e comfort / Lampade con sensore integrat · Siguranță & confort / Lumini senzor ·
Turvallisuus ja mukavuus/tunnistinvalaisimet · Bezpieczeństwo i komfort / światła z czujnikami



RHINE
24



TICINO
29



GANGES
23



NELSON
40



PEARL
36

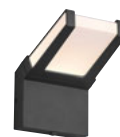

GAMBIA
34



TUNGA
76



TUNGA
76



HORTON
44



CUANDO
70



OHIO
67



HOOSIC
94



HOOSIC
94



NORMAN
108



KASAI
83



PIAVE
88



HORTON
44



PEARL
36



NELSON
40



GAMBIA
34



HOOSIC
94



SAMBESI
126



GRACHT
136



SAMBESI
120

Spots, Einbauleuchten & Zubehör ·

Spotlights, Recessed luminaires & Accessories

Spots, lumières encastrées et accessoires · Spots, inbouwlampen en toebehoren · Puntos de luz, lámparas integradas y accesorios · Faretto, lampade da incasso e sensori · Spoturi, lămpi încorporate & accesorii · Kohdevalaisimet, upotettavat valaisimet ja tarvikkeet · Spoty, światła wpuszczane i akcesoria



TUNGA
78



KELLY
138



HARDEY
139



BELAJA
141



BELAJA
140



UBANGI
145



ERDSPIESS
GROUND SPIKE
148



ECKHALTERUNG
CORNER FASTENING
149



STECKDOSEN
PLUG
146



STECKDOSEN
PLUG
146



STECKDOSEN
PLUG
146



STECKDOSEN
PLUG
147

Outdoor Living Lichtideen · Outdoor Living Lighting Ideas

Idées d'éclairage pour la vie en plein air · Lichtideeën voor buiten · Ideas de luz para la vida al aire libre · Idee di Illuminazione per l'Outdoor Living · Idei de iluminare pentru exterior · Outdoor Living -valaisinideat · Pomysły na oświetlenie zewnętrzne



ARUBA
168



HAITI
169



BERMUDA
166



JAMAICA
165



HAWAII
170



BARBADOS
172



BAHAMAS
172



DORA
173



LORA
173



DOMINGO
174



LENNON
175



PALMAS
164



NECTOR
142



BOLO
176

Solarleuchten · Solar Lights

Lampes solaires · Lampen op zonne-energie · Luces solares · Lampade solari · Lāmpi solare · Aurinkovalaisimet · Światła z zasilaniem słonecznym



POSADAS
180



ESQUEL
182



MENDOZA
184



FOMOSA
184



SALTA
185

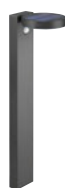

POSADAS
180



ESQUEL
182



MINEROS
186



VINTO
188



MONTERO
191



ARBIETO
190



MINAS
194



CORO
195



LOJA
197



COTOCA
192



CARMELO
194



CAMIRI
193



PARRAL
196



CALDERA
196



MELO
198

MITCHELL

Aluminium Druckguss, Acryl
diecast aluminium, acryl
fonte d'aluminium, acryl
gegoten aluminium, acryl
aluminio fundido, acrílico
pressofusione di alluminio, acrilico
fonta aluminiu, acrilic
valualumiini, akryyli
barwione aluminium, akryl

42 Anthrazit · anthracite

Incl. 1 x SMD-LED, 7,5 W
750 lm, 3.000 K

273360142

IP54

Incl. 1 x SMD-LED, 16,5 W
1.800 lm, 3.000 K

473360442

473369442

IP54

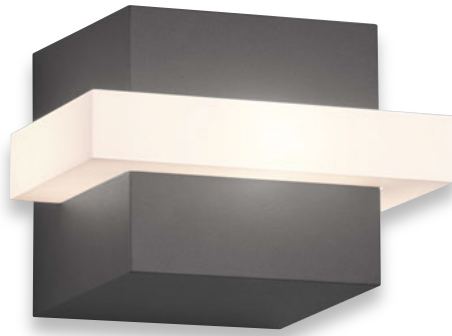

273360142



473360442



473369442

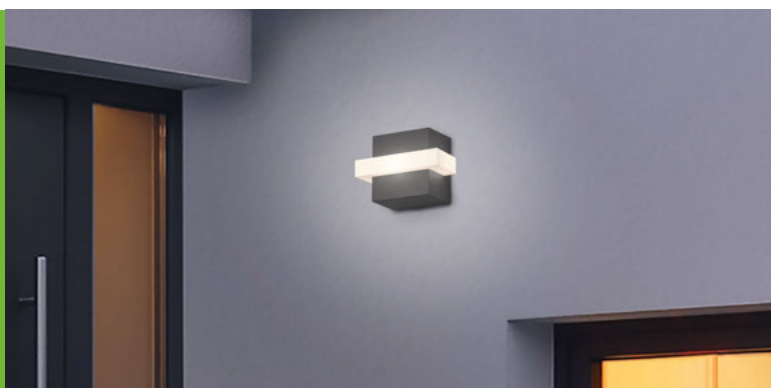
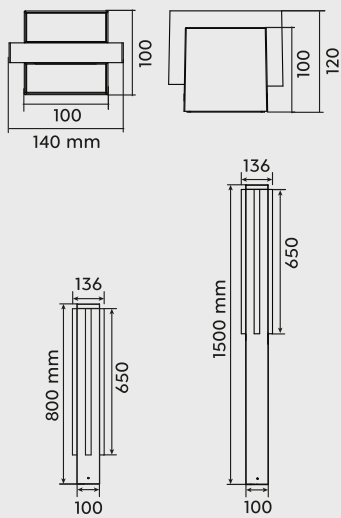



FUERTE

Aluminium Druckguss, Acryl
diecast aluminium, acryl
fonte d'aluminium, acryl
gegoten aluminium, acryl
aluminio fundido, acrílico
pressofusione di alluminio, acrilico
fonta aluminiu, acrilic
valualumiini, akryyli
barwione aluminium, akryl

42 Anthrazit · anthracite

Incl. 1 x SMD-LED, 10,5 W
1.300 lm, 3.000 K

226260142

IP54

Incl. 1 x SMD-LED, 15 W
1.700 lm, 3.000 K

426260142

526260142

IP54



226260142



426260142



526260142

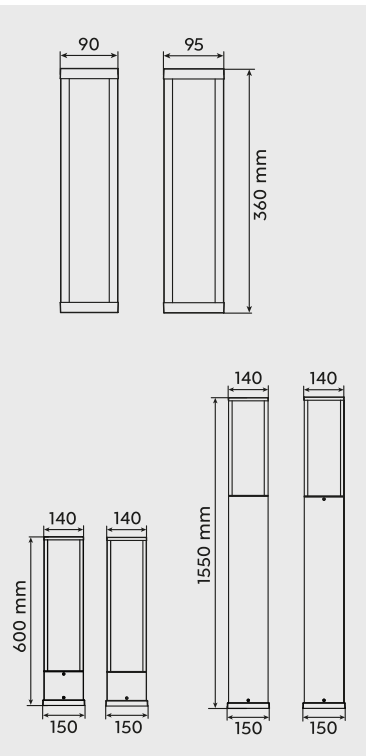



222

LOGONE

Aluminium Druckguss
diecast aluminium
fonte d'aluminium
gegoten aluminium
aluminio fundido
pressofusione di alluminio
fonta aluminu
valualumiini
barwione aluminium

42 Anthrazit · anthracite

Incl. SMD-LED, 11 W
1.100 lm, 3.000 K

IP65

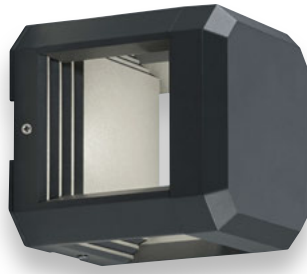
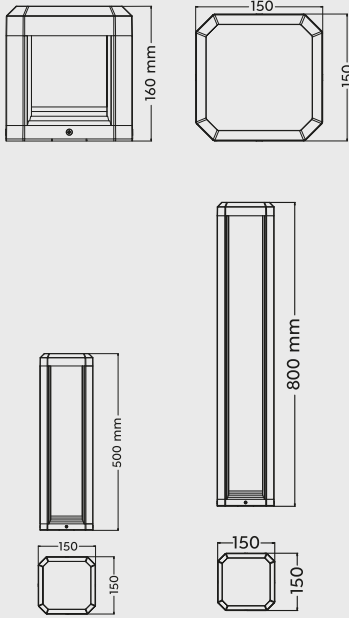

222360142



522360142



422360142

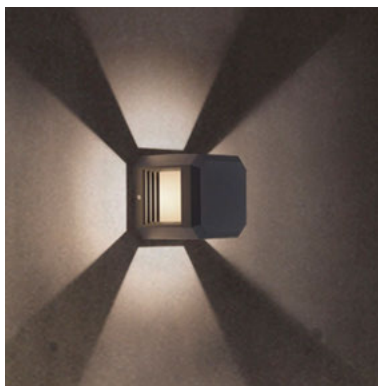



KATUN

Aluminium Druckguss
diecast aluminium
fonte d'aluminium
gegoten aluminium
aluminio fundido
pressofusione di alluminio
fonta aluminii
valualumiini
barwione aluminium

42 Anthrazit · anthracite

Incl. 1 x SMD-LED, 5 W
500 lm, 3.000 K

IP54

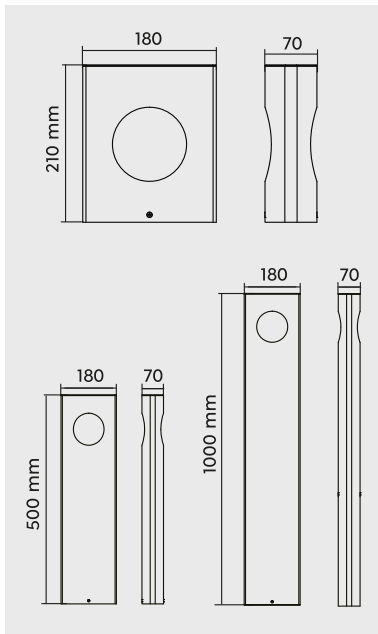

226160142



526160142



426160142





RENO

Aluminium Druckguss
diecast aluminium
fonte d'aluminium
gegoten aluminium
aluminio fundido
pressofusione di alluminio
fonta aluminu
valualumiini
barwione aluminium

42 Anthrazit · anthracite

Incl. 1 x COB-LED, 4,5 W
450 lm, 3.000 K

IP54

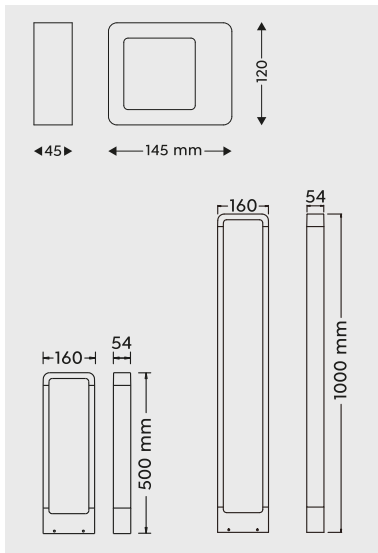

220760142



520760142



420760142

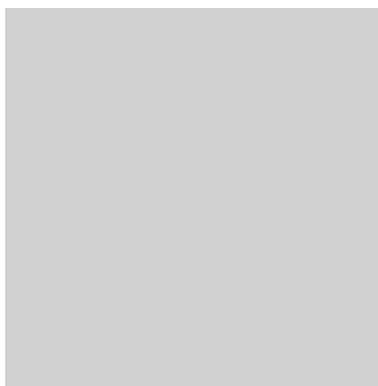
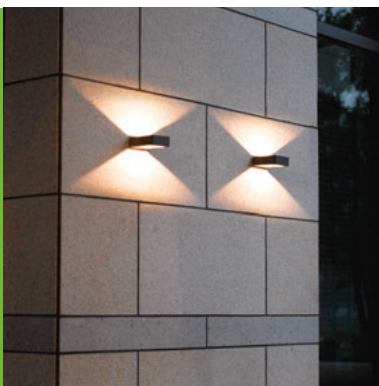



GANGES

Aluminium Druckguss
diecast aluminium
fonte d'aluminium
gegoten aluminium
aluminio fundido
pressofusione di alluminio
fonta aluminii
valualumiini
barwione aluminium

42 Anthrazit · anthracite

Incl. 1 x SMD-LED, 9 W
1.000 lm, 3.000 K

IP54

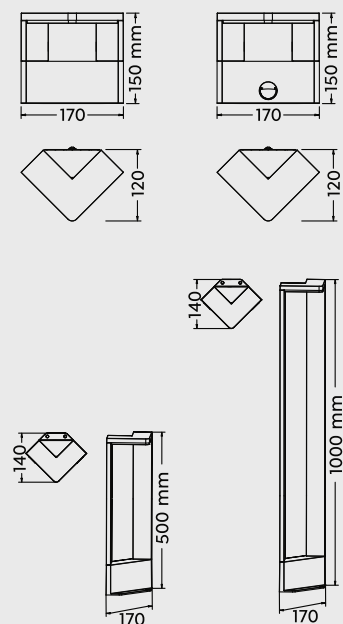

221760142



521760142



421760142





221769142



Bewegungssensor
Motion sensor
Détecteur de mouvement
Bewegungssensor
Sensor de movimiento
Sensore di movimento
Senzor de mișcare
Liiketunnistin
Czujnik ruchu

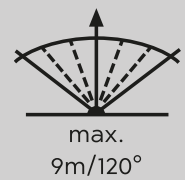

RHINE

Aluminium Druckguss, Kunststoff
 diecast aluminium, plastic
 fonte d'aluminium, plastique
 gegoten aluminium, kunststof
 aluminio fundido, plástico
 pressofusione di alluminio, plastica
 fonta aluminiu, plastic
 valualumiini, muovi
 barwione aluminium, plastik

42 Anthrazit · anthracite

Incl. 2 x SMD-LED, 4,5 W
 2 x 450 lm, 3.000 K

221660242

221669242

Incl. 2 x SMD-LED, 5,5 W
 2 x 600 lm, 3.000 K

421660242

521660242

IP54

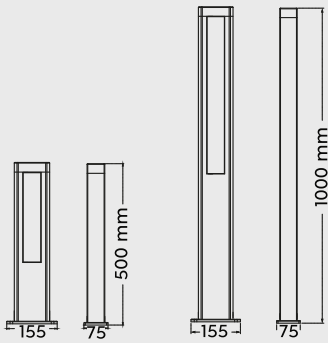
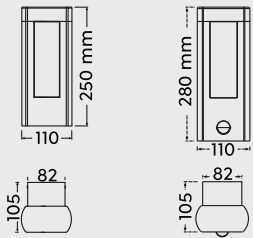

221669242



221660242



521660242



421660242

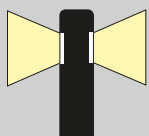

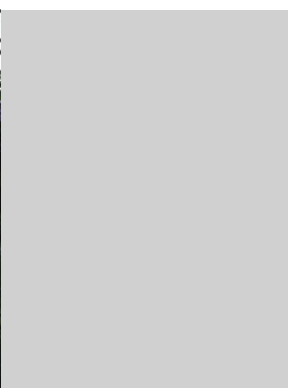

Bewegungssensor
Motion sensor
Décteur de mouvement
Bewegungssensor
Sensor de movimiento
Sensore di movimento
Senzor de mișcare
Liiketunnistin
Czujnik ruchu

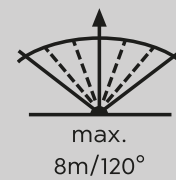

SUEZ

Aluminium Druckguss, Kunststoff
diecast aluminium, plastic
fonte d'aluminium, plastique
gegoten aluminium, kunststof
aluminio fundido, plástico
pressofusione di alluminio, plastica
fonta aluminiu, plastic
valualumiini, muovi
barwione aluminium, plastik

42 Anthrazit · anthracite

Incl. 1 x SMD-LED, 8,5 W
1.000 lm, 3.000 K

IP54

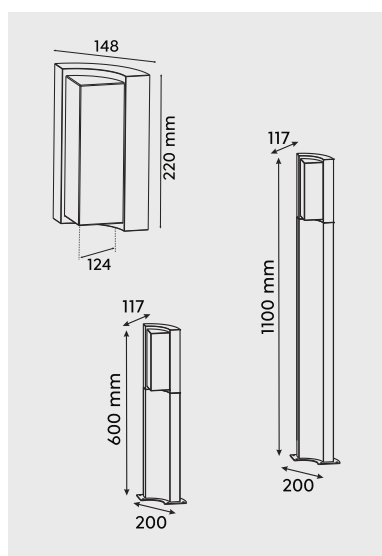

220360142



520360142



420360142

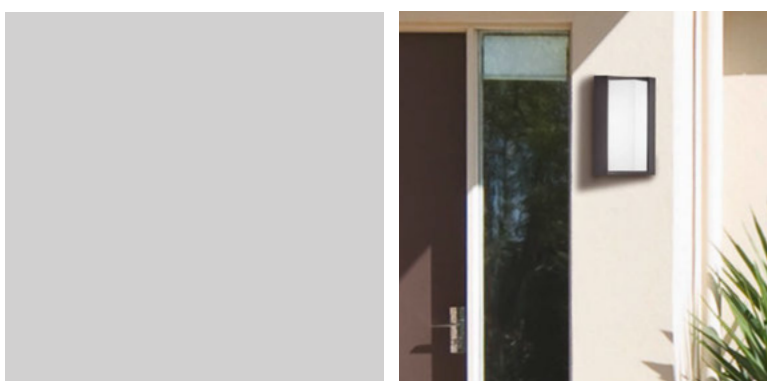



TICINO

Aluminium Druckguss, Kunststoff
diecast aluminium, plastic
fonte d'aluminium, plastique
gegoten aluminium, kunststof
aluminio fundido, plástico
pressofusione di alluminio, plastica
fonta aluminiu, plastic
valualumiini, muovi
barwione aluminium, plastik

42 Anthrazit · anthracite

Incl. 1 x SMD-LED, 5,5 W
550 lm, 3.000 K

IP54



221260142



421260142



521260142

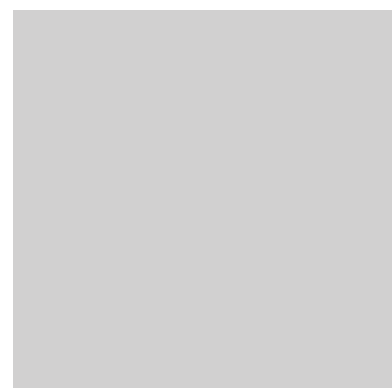
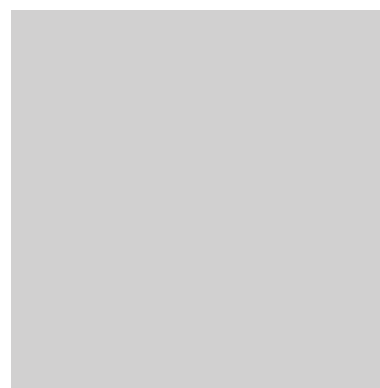
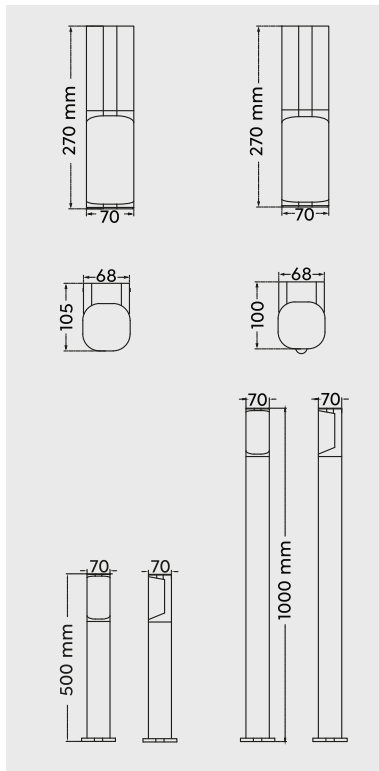



221269142



Bewegungssensor
Motion sensor
Décteur de mouvement
Bewegingssensor
Sensor de movimiento
Sensore di movimento
Senzor de mişcare
Liiketunnistin
Czujnik ruchu

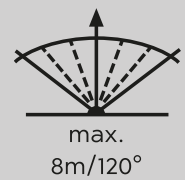

SHANNON

Aluminium Druckguss, Kunststoff
diecast aluminium, plastic
fonte d'aluminium, plastique
gegoten aluminium, kunststof
aluminio fundido, plástico
pressofusione di alluminio, plastica
fonta aluminiu, plastic
valualumiini, muovi
barwione aluminium, plastik

42 Anthrazit · anthracite

Incl. 1 x SMD-LED, 7 W
700 lm, 3.000 K

IP54

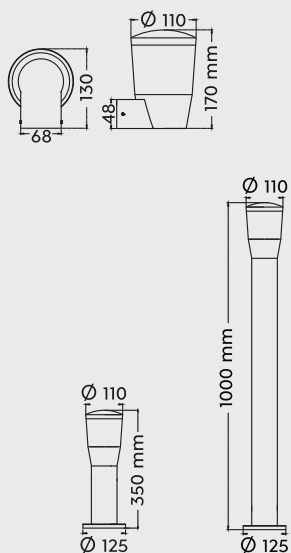

222060142



522060142



422060142

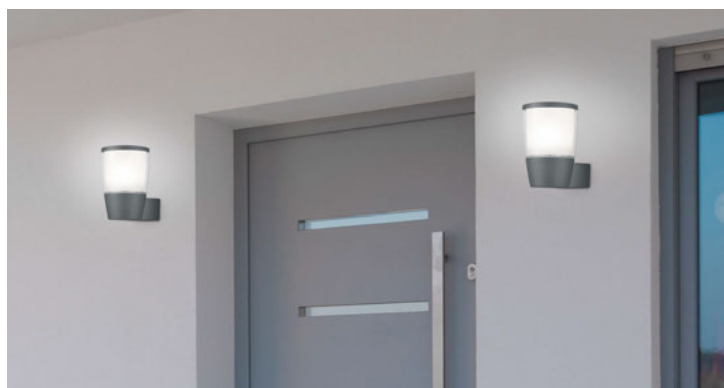



EBRO

Aluminium Druckguss, Kunststoff
diecast aluminium, plastic
fonte d'aluminium, plastique
gegoten aluminium, kunststof
aluminio fundido, plástico
pressofusione di alluminio, plastica
fonta aluminiu, plastic
valualumiini, muovi
barwione aluminium, plastik

42 Anthrazit · anthracite

Incl. 1 x SMD-LED, 6 W
650 lm, 3.000 K

IP54



222160142



522160142



422160142

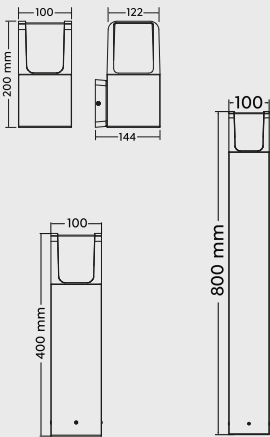

EBRO

Aluminium Druckguss, Kunststoff
diecast aluminium, plastic
fonte d'aluminium, plastique
gegoten aluminium, kunststof
aluminio fundido, plástico
pressofusione di alluminio, plastica
fonta aluminiu, plastic
valualumiini, muovi
barwione aluminium, plastik

42 Anthrazit · anthracite

Incl. 1 x SMD-LED, 6 W
650 lm, 3.000 K

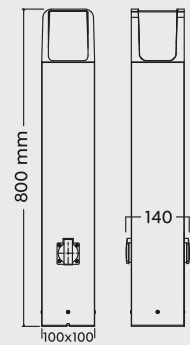

422167142



GAMBIA

Aluminium Druckguss, Kunststoff
 diecast aluminium, plastic
 fonte d'aluminium, plastique
 gegoten aluminium, kunststof
 aluminio fundido, plástico
 pressofusione di alluminio, plastica
 fonta aluminiu, plastic
 valualumiini, muovi
 barwione aluminium, plastik

42 Anthrazit · anthracite

Incl. 1 x SMD-LED, 10,5 W
 1.050 lm, 3.000 K

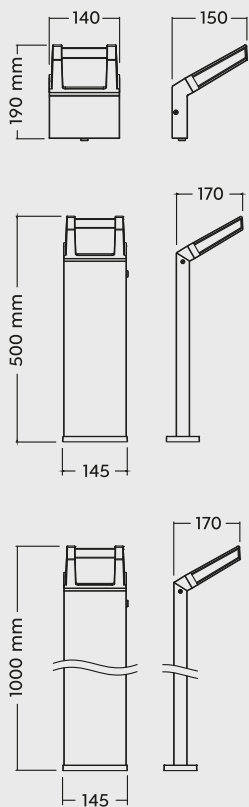

223669142



523669142



423669142



Dämmerungssensor
 Dusk sensor
 Détecteur de crépuscule
 Schemeringsensor
 Sensor de oscuridad
 Sensore crepuscolare
 Senzor de lumina/amurg
 Hämärätunnistin
 Czujnik zmierzchowy





PEARL

Aluminium Druckguss, Kunststoff
 diecast aluminium, plastic
 fonte d'aluminium, plastique
 gegoten aluminium, kunststof
 aluminio fundido, plástico
 pressofusione di alluminio, plastica
 fonta aluminiu, plastic
 valualumiini, muovi
 barwione aluminium, plastik

42 Anthrazit · anthacite

Incl. 1 x SMD-LED, 9 W
 900 lm, 3.000 K



221169142



521169142



421169142

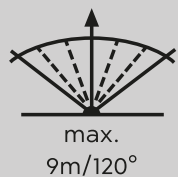
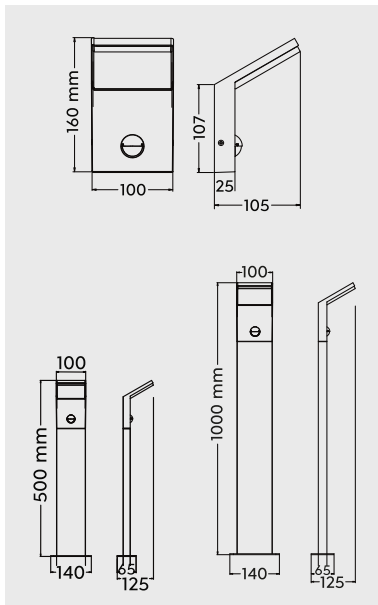

Bewegungssensor
 Motion sensor
 Détecteur de mouvement
 Bewegungssensor
 Sensor de movimiento
 Sensore di movimento
 Senzor de mişcare
 Liiketunnistin
 Czujnik ruchu





PEARL

Aluminium Druckguss, Kunststoff
diecast aluminium, plastic
fonte d'aluminium, plastique
gegoten aluminium, kunststof
aluminio fundido, plástico
pressofusione di alluminio, plastica
fonta aluminiu, plastic
valualumiini, muovi
barwione aluminium, plastik

42 Anthrazit · anthacite

Incl. 1 x SMD-LED, 9 W
900 lm, 3.000 K

IP54

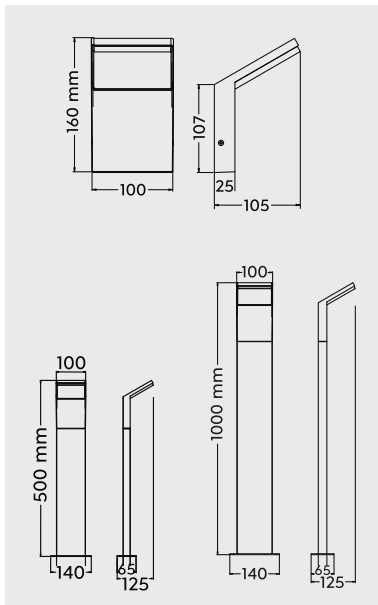

221160142



521160142



421160142





NELSON

Aluminium Druckguss
diecast aluminium
fonte d'aluminium
gegoten aluminium
aluminio fundido
pressofusione di alluminio
fonta aluminiu
valualumiini
barwione aluminium

42 Anthrazit · anthracite

Incl. 1 x SMD-LED, 8 W
850 lm, 3.000 K

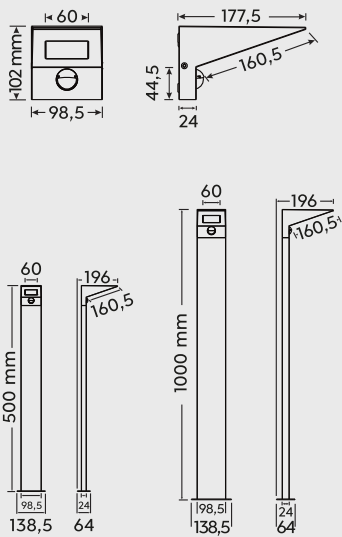

525369142



425369142

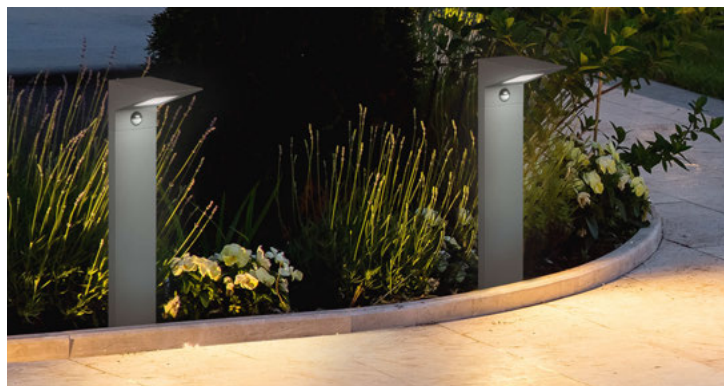



225369142



Bewegungssensor
Motion sensor
Détecteur de mouvement
Bewegungssensor
Sensor de movimiento
Sensore di movimento
Senzor de mișcare
Liiketunnistin
Czujnik ruchu

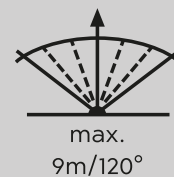

NELSON

Aluminium Druckguss
diecast aluminium
fonte d'aluminium
gegoten aluminium
aluminio fundido
pressofusione di alluminio
fonta aluminiu
valualumiini
barwione aluminium

42 Anthrazit · anthracite

Incl. 1 x SMD-LED, 8 W
850 lm, 3.000 K

IP54

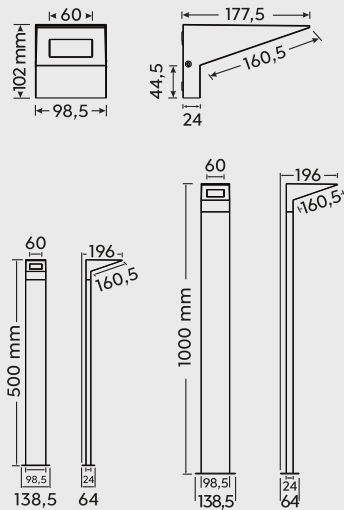

225360142



525360142



425360142





HORTON

Aluminium Druckguss
 diecast aluminium
 fonte d'aluminium
 gegoten aluminium
 aluminio fundido
 pressofusione di alluminio
 fonta aluminii
 valualumiini
 barwione aluminium

42 Anthrazit · anthracite

Incl. 1 x SMD-LED, 8 W
 1.000 lm, 3.000 K

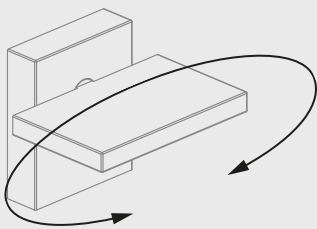
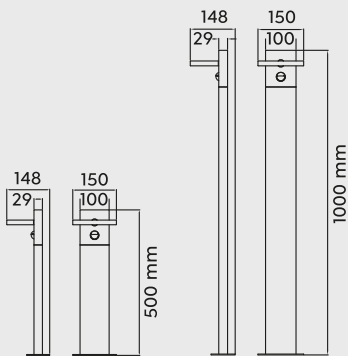
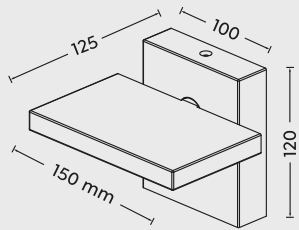

226369142



526369142



426369142



Bewegungssensor
 Motion sensor
 Détecteur de mouvement
 Bewegungssensor
 Sensor de movimiento
 Sensore di movimento
 Senzor de mişcare
 Liiketunnistin
 Czujnik ruchu

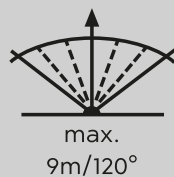



HORTON

Aluminium Druckguss
 diecast aluminium
 fonte d'aluminium
 gegoten aluminium
 aluminio fundido
 pressofusione di alluminio
 fonta aluminii
 valualumiini
 barwione aluminium

42 Anthrazit · anthracite

Incl. 1 x SMD-LED, 8 W
 1.000 lm, 3.000 K

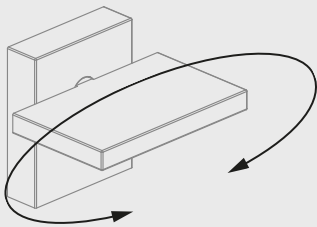
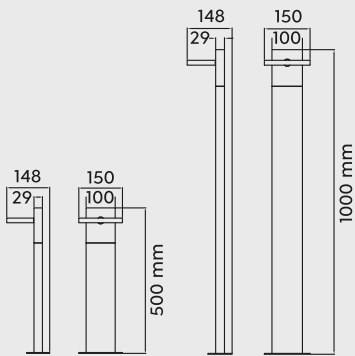
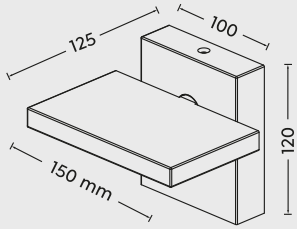

226360142



526360142



426360142

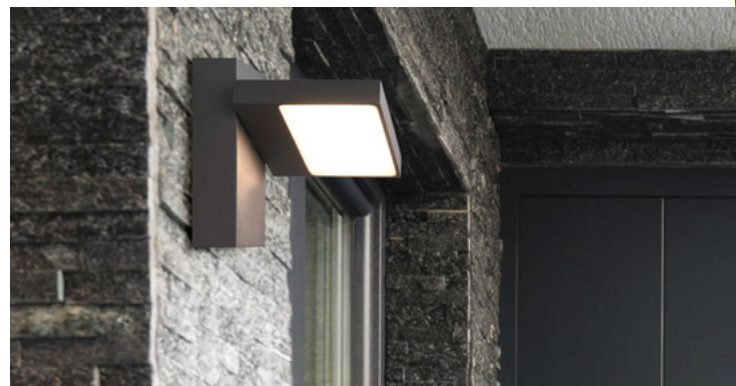



SEINE

Aluminium Druckguss, Kunststoff
diecast aluminium, plastic
fonte d'aluminium, plastique
gegoten aluminium, kunststof
aluminio fundido, plástico
pressofusione di alluminio, plastica
fonta aluminiu, plastic
valualumiini, muovi
barwione aluminium, plastik

42 Anthrazit · anthracite

Incl. 1 x SMD-LED, 6,5 W
750 lm, 3.000 K

IP54

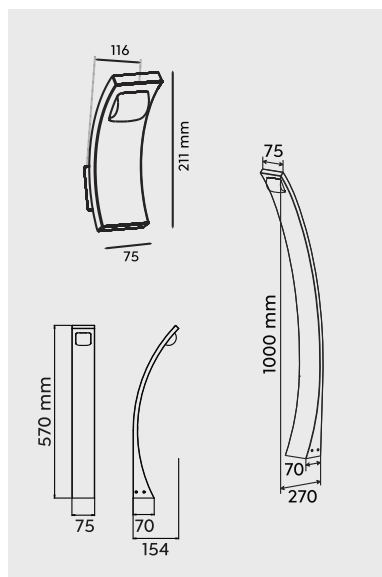

220260142



520260142



420260142





ROYA

Aluminium Druckguss
diecast aluminium
fonte d'aluminium
gegoten aluminium
aluminio fundido
pressofusione di alluminio
fonta aluminiu
valualumiini
barwione aluminium

42 Anthrazit · anthracite

Excl. 2 x GU10, max. 35 W

204260242

204269242



Excl. 1 x GU10, max. 35 W

404260142

504260142

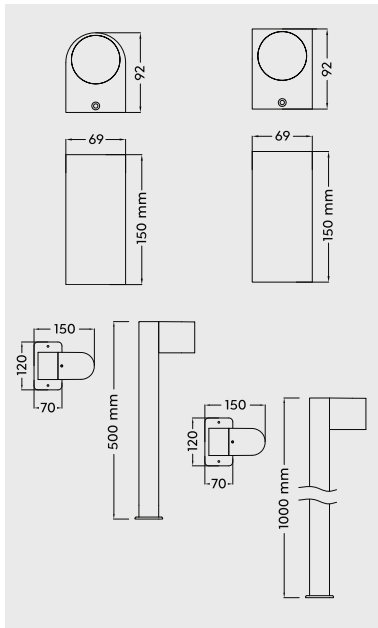

204260242



204269242



504260142



404260142

Empfohlen:
recommended:

LED GU10, 5 W
400 lm, 3.000 K
∠ 120°



956-5936





KAVERI

Aluminium Druckguss
 diecast aluminium
 fonte d'aluminium
 gegoten aluminium
 aluminio fundido
 pressofusione di alluminio
 fonta aluminii
 valualumiini
 barwione aluminium

42 Anthrazit · anthracite

Excl. 1 x GU10, max. 28 W

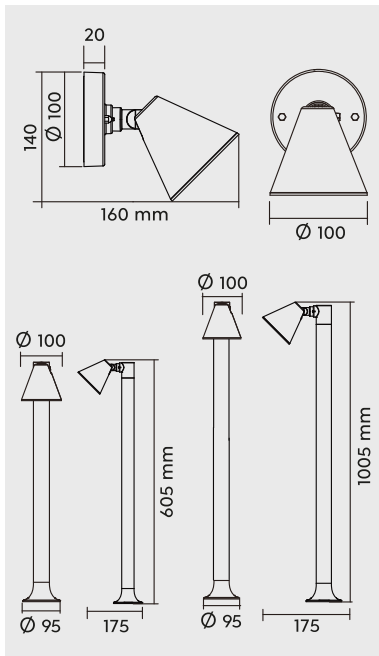

206060142

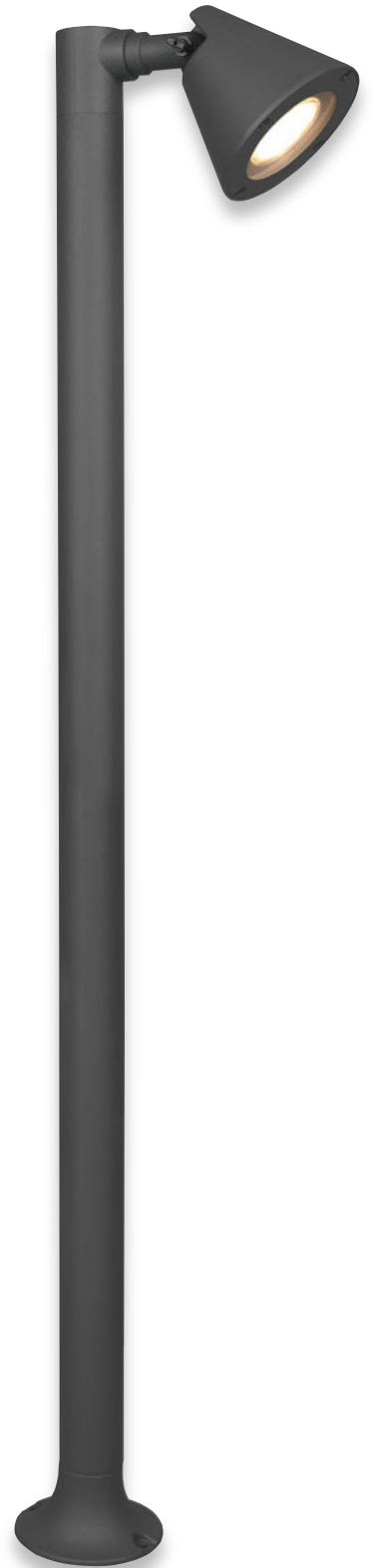

506060142

406060142





COLORADO

Aluminium Druckguss
diecast aluminium
fonte d'aluminium
gegoten aluminium
aluminio fundido
pressofusione di alluminio
fonta aluminiu
valualumiini
barwione aluminium

42 Anthrazit · anthracite

Incl. 2 x SMD-LED, 3 W
2 x 260 lm, 3.000 K

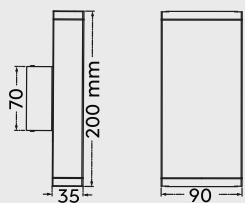

228460242

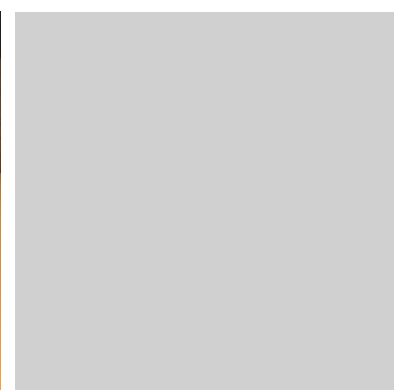
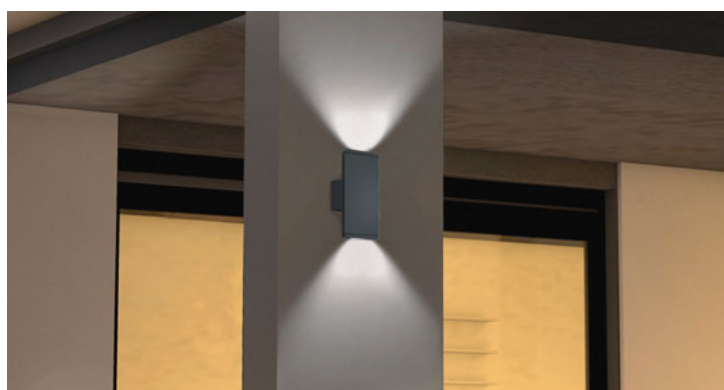

Aluminium Druckguss
 diecast aluminium
 fonte d'aluminium
 gegoten aluminium
 aluminio fundido
 pressofusione di alluminio
 fonta aluminiu
 valualumiini
 barwione aluminium

42 Anthrazit · anthracite

Incl. 1 x SMD-LED, 7,5 W
 800 lm, 3.000 K

IP54

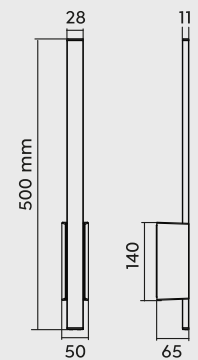

221460142

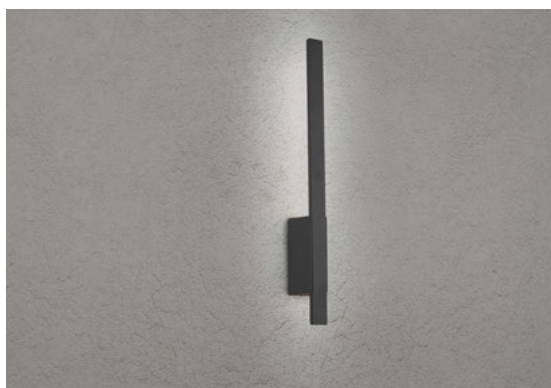

THAMES

Aluminium Druckguss
diecast aluminium
fonte d'aluminium
gegoten aluminium
aluminio fundido
pressofusione di alluminio
fonta aluminiu
valualumiini
barwione aluminium

42 Anthrazit · anthracite

87 titanfarbig · titan

Incl. 2 x SMD-LED, 3 W
2 x 180 lm, 3.000 K

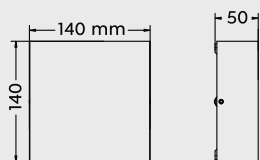

229360242



229360287





THAMES II

Aluminium Druckguss
 diecast aluminium
 fonte d'aluminium
 gegoten aluminium
 aluminio fundido
 pressofusione di alluminio
 fonta aluminiu
 valualumiini
 barwione aluminium

31 Weiß matt · white mat
42 Anthrazit · anthracite
87 titanfarbig · titan

Incl. 2 x SMD-LED, 2,5 W
 2 x 260 lm, 3.000 K

227560231
227560242
227560287



Incl. 2 x SMD-LED, 4,5 W
 2 x 400 lm, 3.000 K

227660231
227660242
227660287

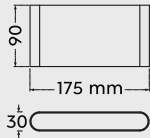
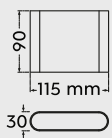

227560231



227560242



227560287



227660231



227660242



227660287

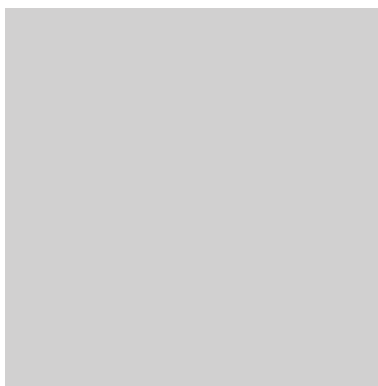

THAMES II

Aluminium Druckguss
diecast aluminium
fonte d'aluminium
gegoten aluminium
aluminio fundido
pressofusione di alluminio
fonta aluminiu
valualumiini
barwione aluminium

31 Weiß matt · white mat

42 Anthrazit · anthracite

87 titanfarbig · titan

Incl. 2 x SMD-LED, 8 W
2 x 800 lm, 3.000 K

226460231

226460242

226460287

IP54

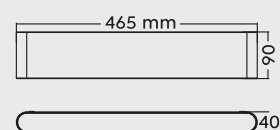

226460242



226460231



226460287

TRENT

Aluminium Druckguss
diecast aluminium
fonte d'aluminium
gegoten aluminium
aluminio fundido
pressofusione di alluminio
fonta aluminu
valualumiini
barwione aluminium

31 Weiß matt · white mat

42 Anthrazit · anthracite

87 titanfarbig · titan

Incl. SMD-LED, 10 W
800 lm, 3.000 K

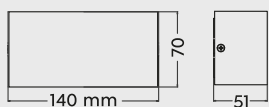

226960231

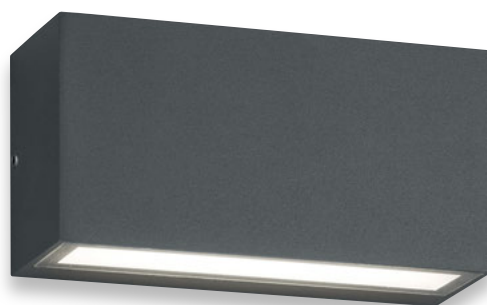

226960242

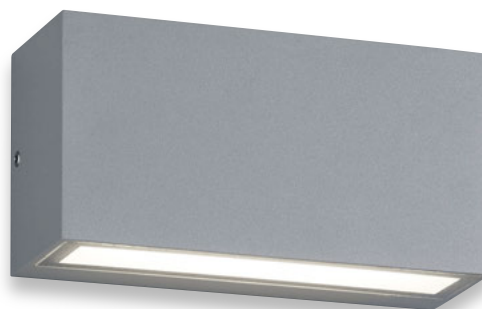

226960287

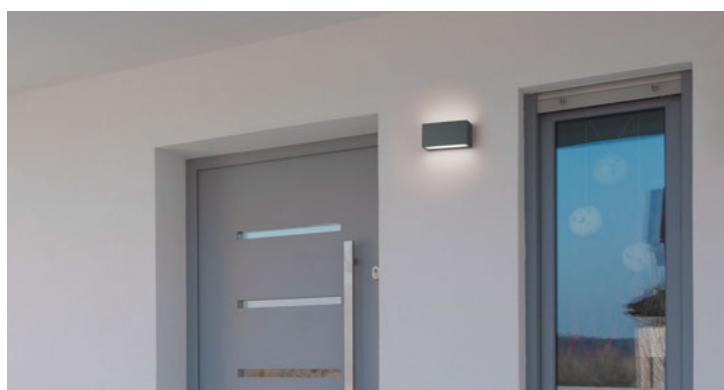

Aluminium Druckguss
 diecast aluminium
 fonte d'aluminium
 gegoten aluminium
 aluminio fundido
 pressofusione di alluminio
 fonta aluminiu
 valualumiini
 barwione aluminium

42 Anthrazit · anthracite

Incl. 2 x SMD-LED, 4,5 W
 2 x 450 lm, 3.000 K

IP65



226560242

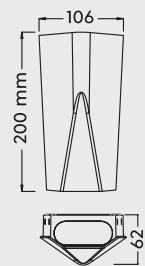

ADAJA

Aluminium Druckguss
diecast aluminium
fonte d'aluminium
gegoten aluminium
aluminio fundido
pressofusione di alluminio
fonta aluminiu
valualumiini
barwione aluminium

31 Weiß matt · white mat
42 Anthrazit · anthracite
87 titanfarbig · titan

Incl. 2 x SMD-LED, 3 W
2 x 240 lm, 3.000 K

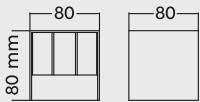

226860231



226860242



226860287

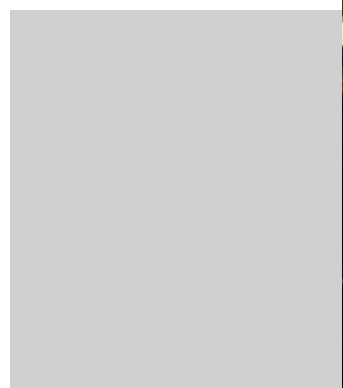
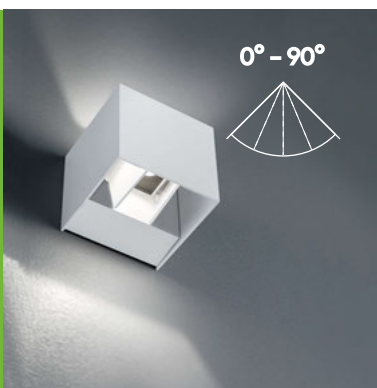



SACRAMENTO

Aluminium Druckguss
diecast aluminium
fonte d'aluminium
gegoten aluminium
aluminio fundido
pressofusione di alluminio
fonta aluminiu
valualumiini
barwione aluminium

31 Weiß matt · white mat

42 Anthrazit · anthracite

Incl. 1 x SMD-LED, 2 W
200 lm, 3.000 K

Incl. 1 x SMD-LED, 5,5 W
550 lm, 3.000 K

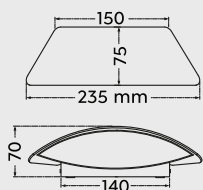

227860231



227860242

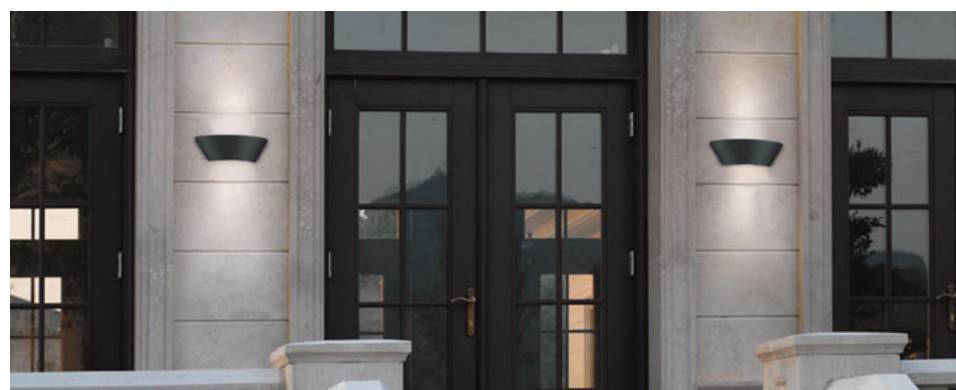

KONDA



228560242

Aluminium Druckguss, Kunststoff
diecast aluminium, plastic
fonte d'aluminium, plastique
gegoten aluminium, kunststof
aluminio fundido, plástico
pressofusione di alluminio, plastica
fonta aluminiu, plastic
valualumiini, muovi
barwione aluminium, plastik

42 Anthrazit · anthracite

Incl. 1 x SMD-LED, 9 W
850 lm, 3.000 K

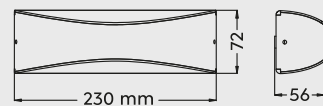

HARLEM

Aluminium Druckguss, Kunststoff
diecast aluminium, plastic
fonte d'aluminium, plastique
gegoten aluminium, kunststof
aluminio fundido, plástico
pressofusione di alluminio, plastica
fonta aluminiu, plastic
valualumiini, muovi
barwione aluminium, plastik

42 Anthrazit · anthracite

87 titanfarbig · titan

Incl. 1 x SMD-LED, 6 W
580 lm, 3.000 K

IP54

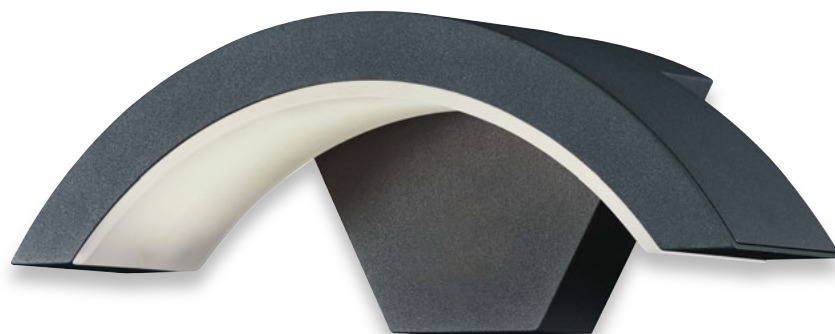
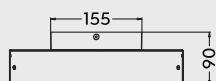
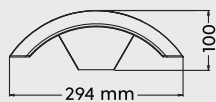

220960142

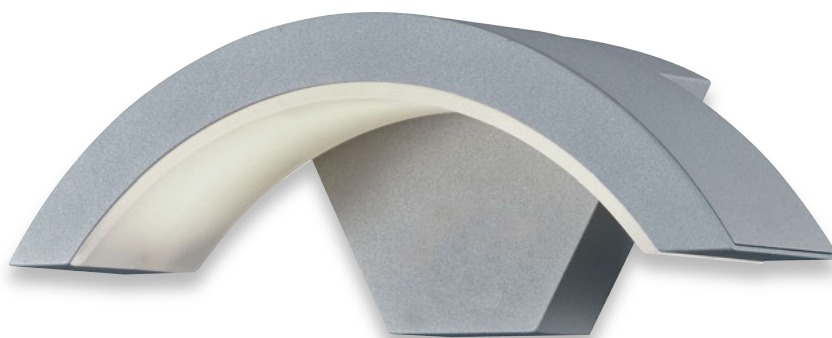

220960187

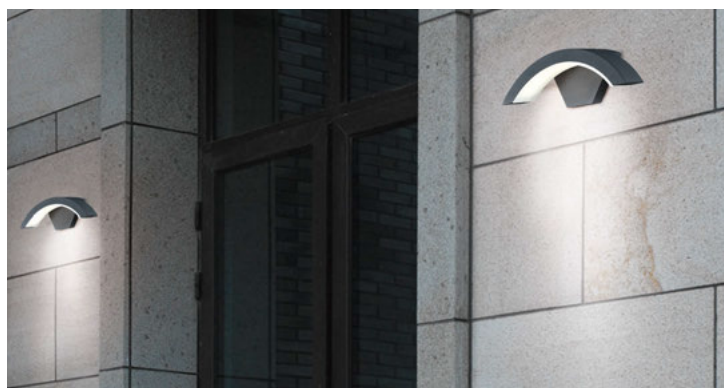

OHIO

Aluminium Druckguss, Kunststoff
diecast aluminium, plastic
fonte d'aluminium, plastique
gegoten aluminium, kunststof
aluminio fundido, plástico
pressofusione di alluminio, plastica
fonta aluminiu, plastic
valualumiini, muovi
barwione aluminium, plastik

42 Anthrazit · anthracite

87 titanfarbig · titan

Incl. 1 x SMD-LED, 6 W
580 lm, 3.000 K



220969187

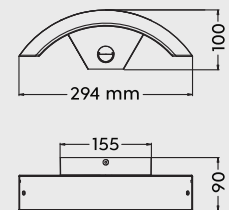

220969142



Bewegungssensor
Motion sensor
Décteur de mouvement
Bewegingssensor
Sensor de movimiento
Sensore di movimento
Senzor de mişcare
Liiketunnistin
Czujnik ruchu

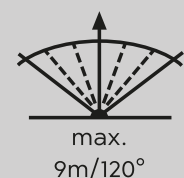

TRAVE

Aluminium Druckguss, Kunststoff
diecast aluminium, plastic
fonte d'aluminium, plastique
gegoten aluminium, kunststof
aluminio fundido, plástico
pressofusione di alluminio, plastica
fonta aluminiu, plastic
valualumiini, muovi
barwione aluminium, plastik

01 Weiß · white

42 Anthrazit · anthracite

Incl. 1 x SMD-LED, 6,5 W
700 lm, 3.000 K

IP54

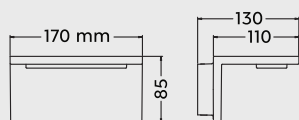

228760101



228760142

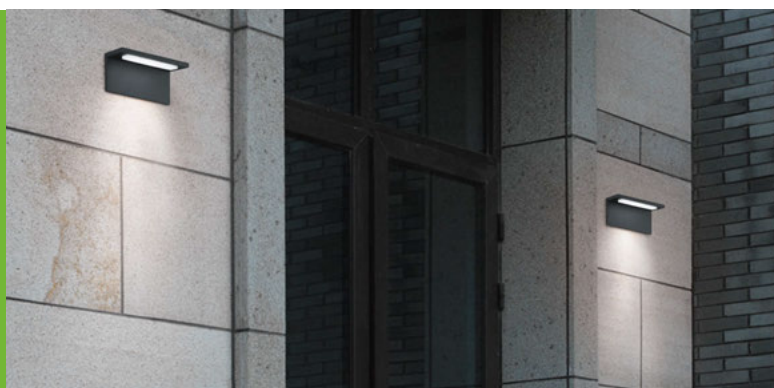

TRAVE

Aluminium Druckguss, Kunststoff
diecast aluminium, plastic
fonte d'aluminium, plastique
gegoten aluminium, kunststof
aluminio fundido, plástico
pressofusione di alluminio, plastica
fonta aluminiu, plastic
valualumiini, muovi
barwione aluminium, plastik

42 Anthrazit · anthracite

Incl. SMD-LED, 18 W
1.750 lm, 3.000 K

IP54

620160142

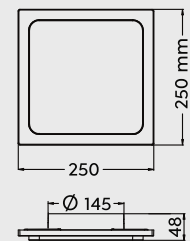

CUANDO

Aluminium Druckguss, Acryl
diecast aluminium, acryl
fonte d'aluminium, acryl
gegoten aluminium, acryl
aluminio fundido, acrílico
pressofusione di alluminio, acrilico
fonta aluminiu, acrilic
valualumiini, akryyli
barwione aluminium, akryl

42 Anthrazit · anthracite

Incl. SMD-LED, 14 W
1.000 lm, 3.000 K

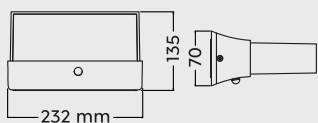
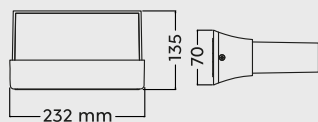

226660242



226669242

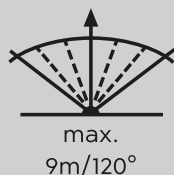
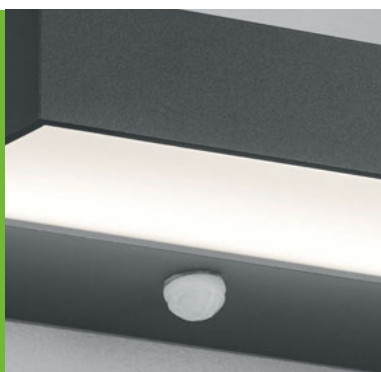

Bewegungssensor
Motion sensor
Détecteur de mouvement
Bewegingssensor
Sensor de movimiento
Sensore di movimento
Senzor de mişcare
Liiketunnistin
Czujnik ruchu

INDUS

Aluminium Druckguss, Kunststoff
diecast aluminium, plastic
fonte d'aluminium, plastique
gegoten aluminium, kunststof
aluminio fundido, plástico
pressofusione di alluminio, plastica
fonta aluminiu, plastic
valualumiini, muovi
barwione aluminium, plastik

42 Anthrazit · anthracite

Incl. 1 x SMD-LED, 8,5 W
850 lm, 3.000 K

IP54

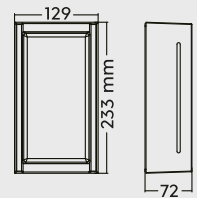

227360142



YANGTZE

Aluminium Druckguss, Kunststoff
diecast aluminium, plastic
fonte d'aluminium, plastique
gegoten aluminium, kunststof
aluminio fundido, plástico
pressofusione di alluminio, plastica
fonta aluminiu, plastic
valualumiini, muovi
barwione aluminium, plastik

01 Weiß · white

42 Anthrazit · anthracite

Incl. 1 x SMD-LED, 3,5 W
330 lm, 3.000 K

IP54

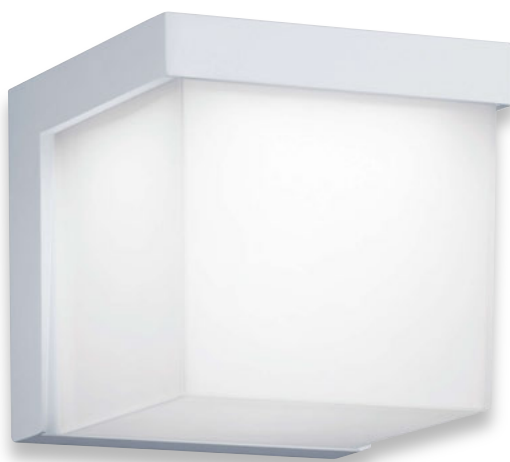
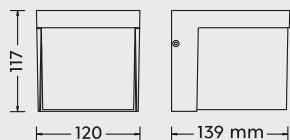

228260101



228260142



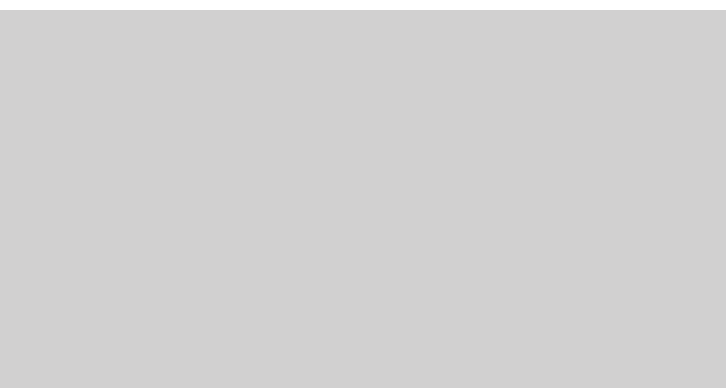

TIBER

Aluminium Druckguss
diecast aluminium
fonte d'aluminium
gegoten aluminium
aluminio fundido
pressofusione di alluminio
fonta aluminiu
valualumiini
barwione aluminium

42 Anthrazit · anthracite

Incl. 1 x COB-LED, 3 W
210 lm, 3.000 K

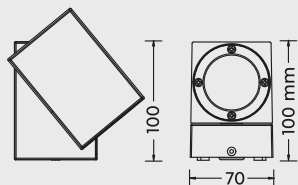

229160142

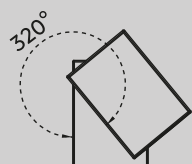

PADMA

Aluminium Druckguss
diecast aluminium
fonte d'aluminium
gegoten aluminium
aluminio fundido
pressofusione di alluminio
fonta aluminiu
valualumiini
barwione aluminium

42 Anthrazit · anthracite

Incl. 2 x SMD-LED, 4,5 W
2 x 420 lm, 3.000 K



227160242

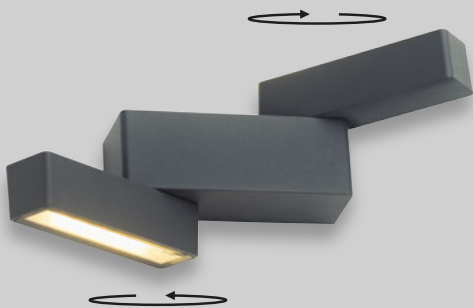
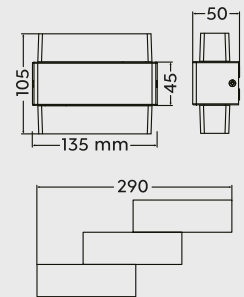

Schwenkbar
Tilttable
Pivotant
Draaibaar
Pivotante
Girevole
Pivotant
Suunnattava
Skreṭny



TUNGA

Aluminium Druckguss
 diecast aluminium
 fonte d'aluminium
 gegoten aluminium
 aluminio fundido
 pressofusione di alluminio
 fonta aluminiu
 valualumiini
 barwione aluminium

31 Weiß matt · white mat
42 Anthrazit · anthracite

Incl. 1 x SMD-LED, 3,5 W
 420 lm, 3.000 K

222969131
222969142



Incl. 2 x SMD-LED, 3,5 W
 2 x 420 lm, 3.000 K

222969231
222969242



222969131



222969142



222969231

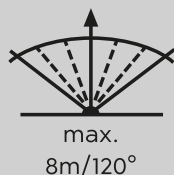
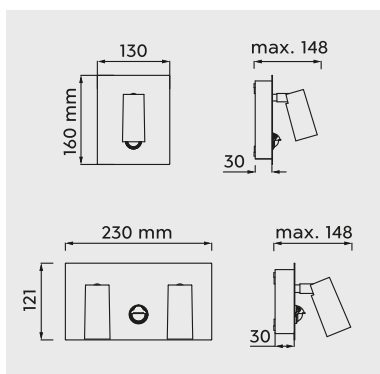

Bewegungssensor
 Motion sensor
 Détecteur de mouvement
 Bewegungssensor
 Sensor de movimiento
 Sensore di movimento
 Senzor de mişcare
 Liiketunnistin
 Czujnik ruchu

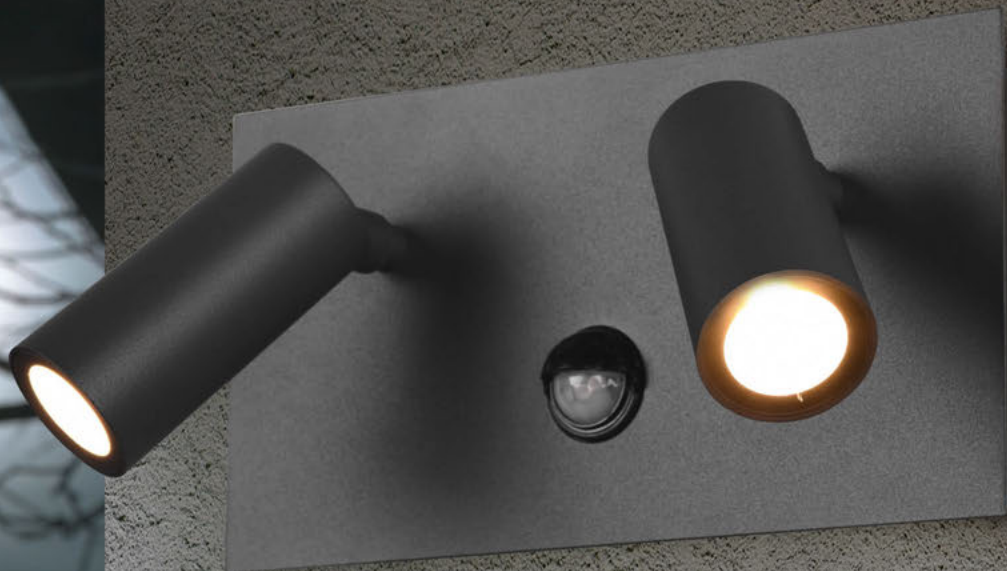

222969242

TUNGA

Aluminium Druckguss
diecast aluminium
fonte d'aluminium
gegoten aluminium
aluminio fundido
pressofusione di alluminio
fonta aluminii
valualumiini
barwione aluminium

31 Weiß matt · white mat
42 Anthrazit · anthracite

Incl. 1 x SMD-LED, 3,5 W
420 lm, 3.000 K

222960131
222960142

IP54

Incl. 2 x SMD-LED, 3,5 W
2 x 420 lm, 3.000 K

222960231
222960242

IP54



222960131



222960142

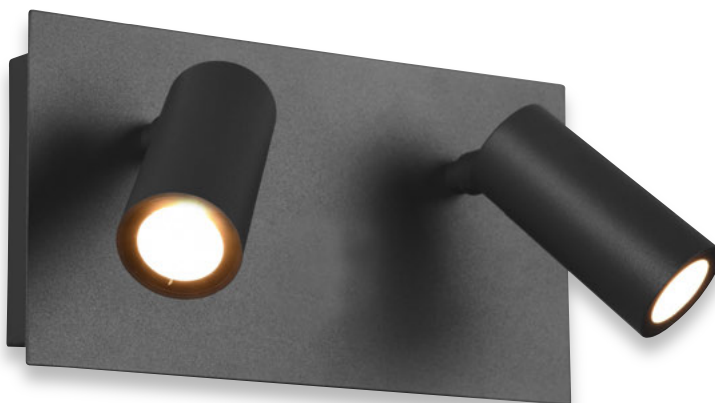

222960242

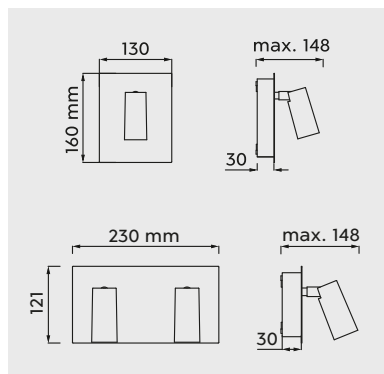



222960231

MUGA

Aluminium Druckguss, Kunststoff
diecast aluminium, plastic
fonte d'aluminium, plastique
gegoten aluminium, kunststof
aluminio fundido, plástico
pressofusione di alluminio, plastica
fonta aluminu, plastic
valualumiini, muovi
barwione aluminium, plastik

01 Weiß · white

42 Anthrazit · anthracite

Incl. 1 x SMD-LED, 5 W
550 lm, 3.000 K

IP54

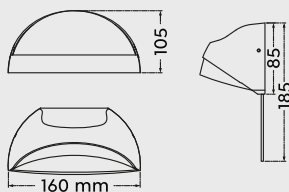

228360142



228360101





20

PECOS

Aluminium Druckguss, Kunststoff
diecast aluminium, plastic
fonte d'aluminium, plastique
gegoten aluminium, kunststof
aluminio fundido, plástico
pressofusione di alluminio, plastica
fonta aluminiu, plastic
valualumiini, muovi
barwione aluminium, plastik

42 Anthrazit · anthracite

Incl. 1 x SMD-LED, 6 W
600 lm, 3.000 K

IP54

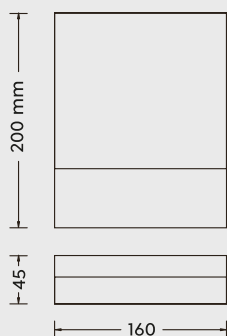

227760142

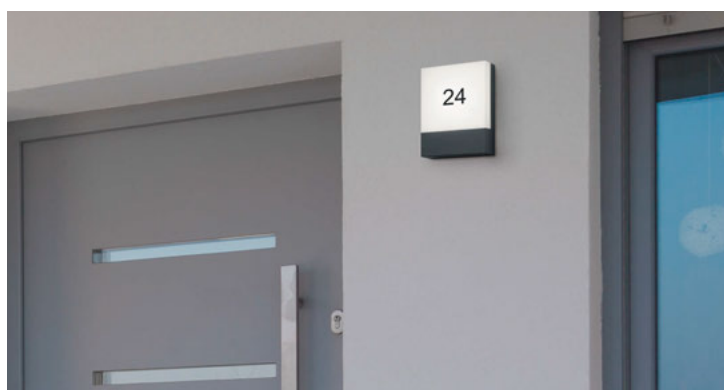

KASAI

Aluminium Druckguss, Kunststoff
diecast aluminium, plastic
fonte d'aluminium, plastique
gegooten aluminium, kunststof
aluminio fundido, plástico
pressofusione di alluminio, plastica
fonta aluminiu, plastic
valualumiini, muovi
barwione aluminium, plastik

42 Anthrazit · anthracite

Incl. 1 x SMD-LED, 9 W
850 lm, 3.000 K

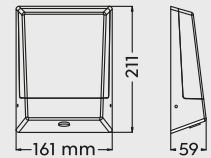

228669142



Dämmerungssensor
Dusk sensor
Décteur de crépuscule
Schemeringsensor
Sensor de oscuridad
Sensore crepuscolare
Senzor de lumina/amurg
Hämärätunnistin
Czujnik zmierzchowy
Alacakaranlık Algılayıcısı



TIMOK

Aluminium Druckguss, Kunststoff
diecast aluminium, plastic
fonte d'aluminium, plastique
gegoten aluminium, kunststof
aluminio fundido, plástico
pressofusione di alluminio, plastica
fonta aluminiu, plastic
valualumiini, muovi
barwione aluminium, plastik

01 Weiß · white

42 Anthrazit · anthracite

Incl. 1 x LED E27, 5 W
470 lm, 3.000 K

IP54

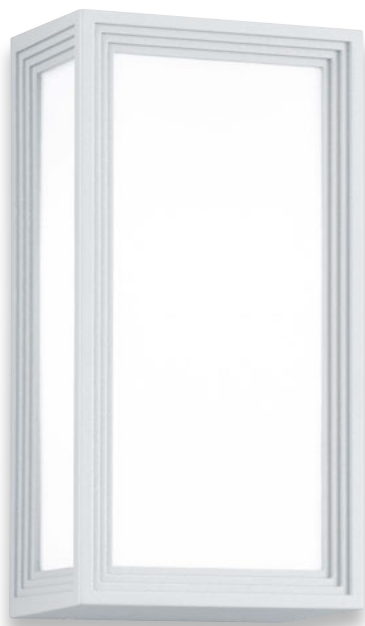
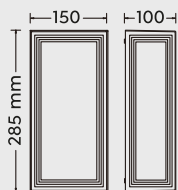

228060101



228060142

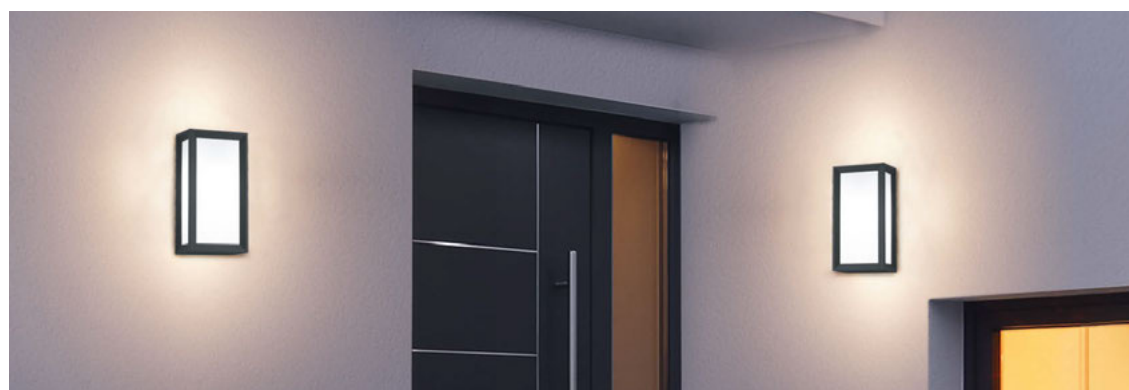

HONDO

Aluminium Druckguss, Kunststoff
diecast aluminium, plastic
fonte d'aluminium, plastique
gegoten aluminium, kunststof
aluminio fundido, plástico
pressofusione di alluminio, plastica
fonta aluminiu, plastic
valualumiini, muovi
barwione aluminium, plastik

01 Weiß · white

42 Anthrazit · anthracite

Incl. 1 x SMD-LED, 3,5 W
330 lm, 3.000 K

IP54

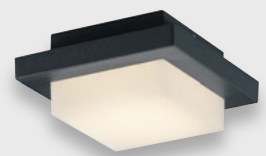
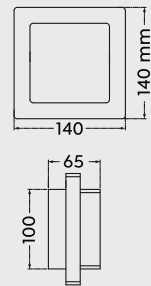

228960142

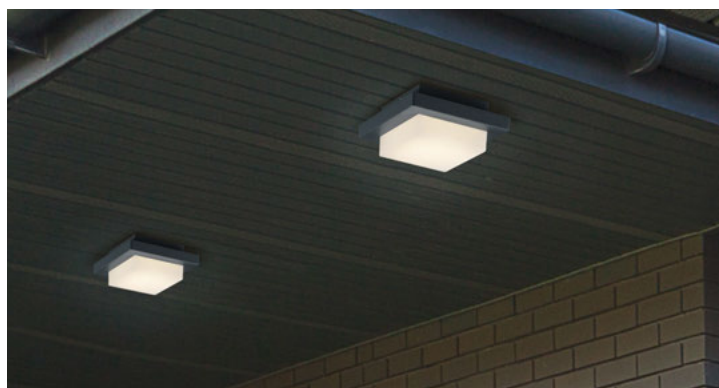

BREG

Aluminium Druckguss, Kunststoff
diecast aluminium, plastic
fonte d'aluminium, plastique
gegoten aluminium, kunststof
aluminio fundido, plástico
pressofusione di alluminio, plastica
fonta aluminiu, plastic
valualumiini, muovi
barwione aluminium, plastik

42 Anthrazit · anthracite

Incl. 1 x SMD-LED, 8,5 W
850 lm, 3.000 K

IP54

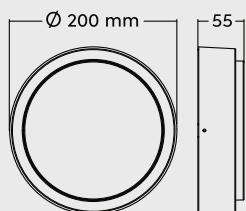

227260142

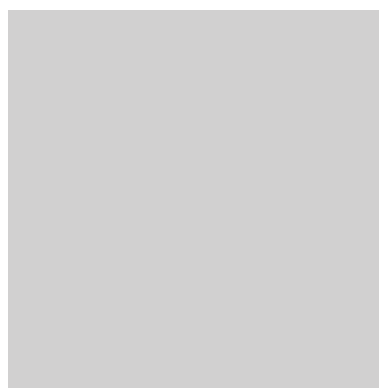

PEDRO

Aluminium Druckguss, Acryl
diecast aluminium, acryl
fonte d'aluminium, acryl
gegoten aluminium, acryl
aluminio fundido, acrílico
pressofusione di alluminio, acrilico
fonta aluminiu, acrilic
valualumiini, akryyli
barwione aluminium, akryl

42 Anthrazit · anthracite

Incl. 1 x SMD-LED, 9 W
1.000 lm, 3.000 K

IP54

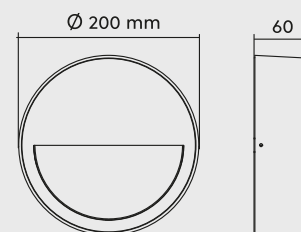

222860142



PIAVE

Kunststoff
plastic
plastique
kunststof
plástico
plastica
plastic
muovi
plastik

31 Weiß matt · white mat

42 Anthrazit · anthracite

Incl. SMD-LED, 12 W
1.000 lm, 3.000 K

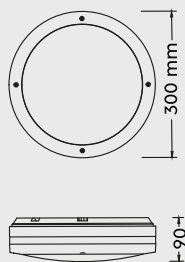

676960131



676960142

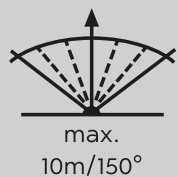

Bewegungssensor
Motion sensor
Détecteur de mouvement
Bewegingssensor
Sensor de movimiento
Sensore di movimento
Senzor de mişcare
Liiketunnistin
Czujnik ruchu





MURRAY

Kunststoff
plastic
plastique
kunststof
plástico
plastica
plastic
muovi
plastik

24 rostfarbig · rusty

78 betonfarbig · concrete look

Excl. 2 x E27, max. 12 W



IP54

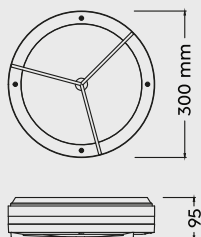

676160224



676160278

Empfohlen:
recommended:

LED E27, 6 W
470 lm, 3.000 K



987-60

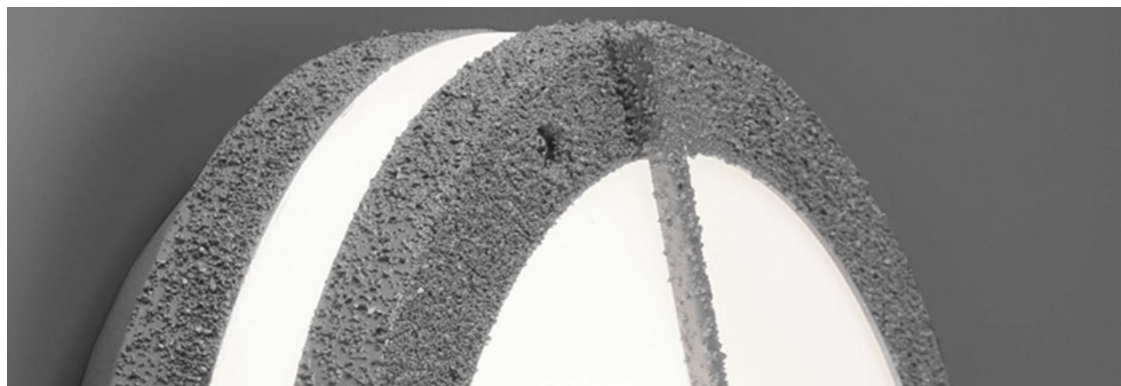



HOOSIC

Aluminium Druckguss, Kunststoff
 diecast aluminium, plastic
 fonte d'aluminium, plastique
 gegoten aluminium, kunststof
 aluminio fundido, plástico
 pressofusione di alluminio, plastica
 fonta aluminiu, plastic
 valualumiini, muovi
 barwione aluminium, plastik

24 rostfarbig · rusty

Excl. 1 x E27, max. 28 W

222260124

422260124

522260124

Excl. 2 x E27, max. 28 W

222260224



IP44



222260124



222260224



522260124



422260124

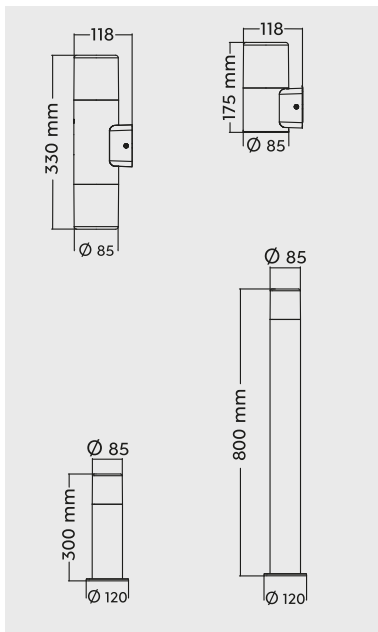

Empfohlen:
 recommended:

Filament LED
 E27, 6 W
 470 lm, 3.000 K



987-60

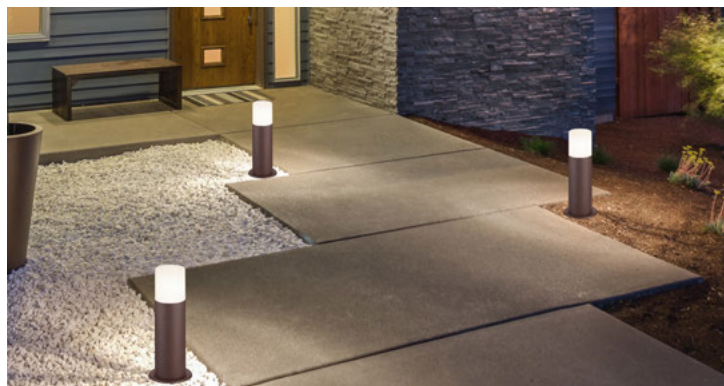



HOOSIC

Aluminium Druckguss, Kunststoff
 diecast aluminium, plastic
 fonte d'aluminium, plastique
 gegoten aluminium, kunststof
 aluminio fundido, plástico
 pressofusione di alluminio, plastica
 fonta aluminiu, plastic
 valualumiini, muovi
 barwione aluminium, plastik

42 Anthrazit · anthracite

Excl. 1 x E27, max. 28 W

222260142

422260142

522260142

Excl. 2 x E27, max. 28 W

222260242



222260142



222260242



522260142



422260142

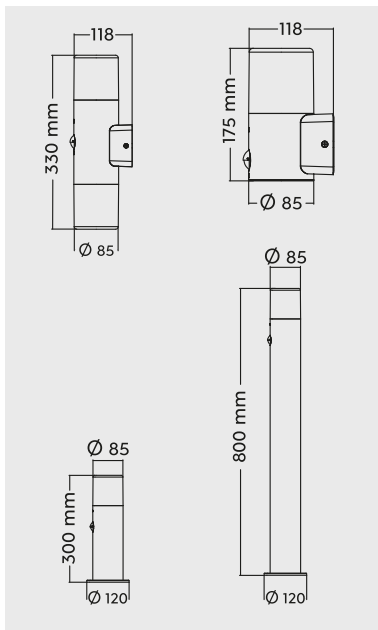

Empfohlen:
 recommended:

Filament LED
 E27, 6 W
 470 lm, 3.000 K



987-60



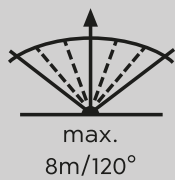

Bewegungssensor
Motion sensor
Détecteur de mouvement
Bewegungssensor
Sensor de movimiento
Sensore di movimento
Senzor de mișcare
Liiketunnistin
Czujnik ruchu



HOOSIC

Aluminium Druckguss, Kunststoff
 diecast aluminium, plastic
 fonte d'aluminium, plastique
 gegoten aluminium, kunststof
 aluminio fundido, plástico
 pressofusione di alluminio, plastica
 fonta aluminiu, plastic
 valualumiini, muovi
 barwione aluminium, plastik

42 Anthrazit · anthracite

Excl. 1 x E27, max. 28 W

224060142

424060142

524060142

Excl. 2 x E27, max. 28 W

224060242



224060142



224060242



424060142



524060142

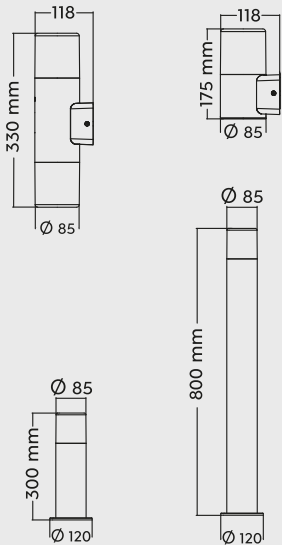

Empfohlen:
 recommended:

Filament LED
 E27, 6 W
 470 lm, 3.000 K



987-60



HOOSIC

Aluminium Druckguss, Kunststoff
diecast aluminium, plastic
fonte d'aluminium, plastique
gegoten aluminium, kunststof
aluminio fundido, plástico
pressofusione di alluminio, plastica
fonta aluminiu, plastic
valualumiini, muovi
barwione aluminium, plastik

42 Anthrazit · anthracite

Excl. 1 x E27, max. 28 W



IP44

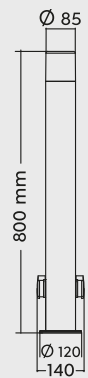

424067142



HUDSON

Aluminium Druckguss, Kunststoff
 diecast aluminium, plastic
 fonte d'aluminium, plastique
 gegoten aluminium, kunststof
 aluminio fundido, plástico
 pressofusione di alluminio, plastica
 fonta aluminiu, plastic
 valualumiini, muov
 barwione aluminium, plastik

42 Anthrazit · anthracite

Incl. 1 x LED E14, 4 W
 320 lm, 3.000 K

220060142

420060142

520060142

Incl. 2 x LED E14, 4 W
 2 x 320 lm, 3.000 K

220060242

IP44



220060142



220060242



520060142



420060142

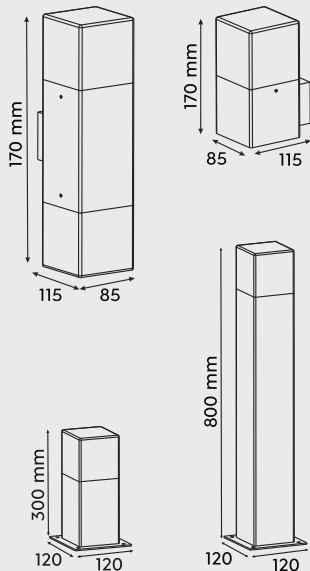

Incl. LED E14, 4 W
 320 lm, 3.000 K



983-40

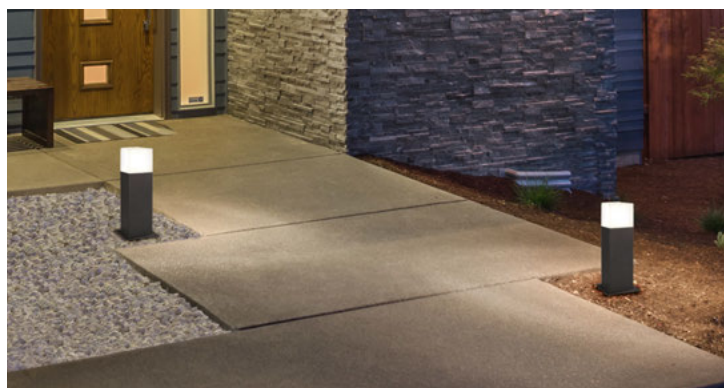



HUDSON

Aluminium Druckguss, Kunststoff
 diecast aluminium, plastic
 fonte d'aluminium, plastique
 gegoten aluminium, kunststof
 aluminio fundido, plástico
 pressofusione di alluminio, plastica
 fonta aluminiu, plastic
 valualumiini, muovi
 barwione aluminium, plastik

87 titanfarbig · titan

Incl. 1 x LED E14, 4 W
 320 lm, 3.000 K

220060187

420060187

520060187

Incl. 2 x LED E14, 4 W
 2 x 320 lm, 3.000 K

220060287

IP44

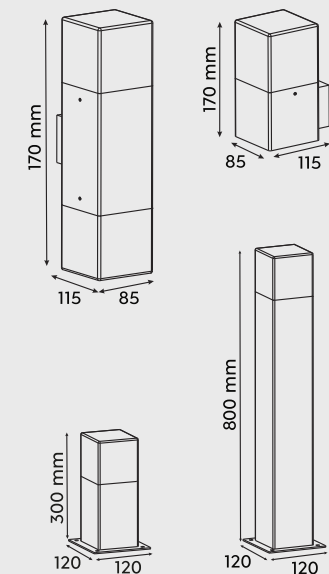

220060187



220060287



520060187



420060187

Incl. LED E14, 4 W
 320 lm, 3.000 K



983-40





CUBANGO

Aluminium Druckguss, Kunststoff
diecast aluminium, plastic
fonte d'aluminium, plastique
gegoten aluminium, kunststof
aluminio fundido, plástico
pressofusione di alluminio, plastica
fonta aluminiu, plastic
valualumiini, muovi
barwione aluminium, plastik

42 Anthrazit · anthracite

Incl. 1 x LED E27, 5 W
400 lm, 3.000 K

IP54

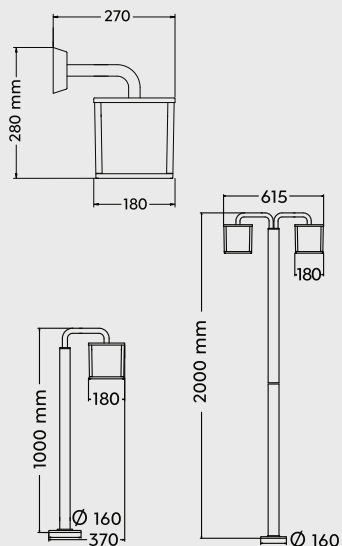

221560142



421560142



421560242

Incl. LED E27, 5 W
400 lm, 3.000 K



986-60





DONEZ

Aluminium Druckguss, Glas
diecast aluminium, glass
fonte d'aluminium, verre
gegoten aluminium, glas
aluminio fundido, vidrio
pressofusione di alluminio, vetro
fonta aluminiu, sticla
valualumiini, lasi
barwione aluminium, szkło

42 Anthrazit · anthracite

Excl. 1 x E27, max. 40 W



IP44

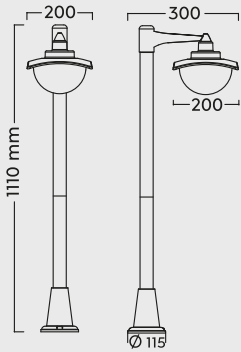
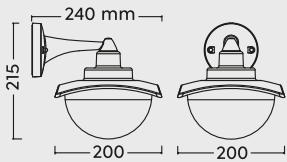

204960142



404960142

Empfohlen:
recommended:

LED E27, 5 W
400 lm, 3.000 K



986-60

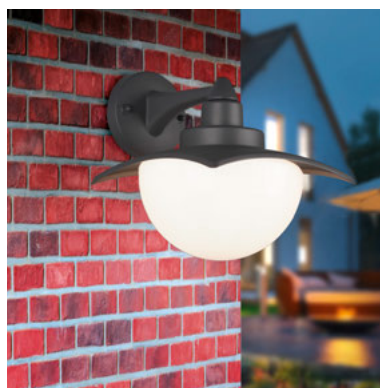



KONGO

Aluminium Druckguss, Kunststoff
diecast aluminium, plastic
fonte d'aluminium, plastique
gegoten aluminium, kunststof
aluminio fundido, plástico
pressofusione di alluminio, plastica
fonta aluminiu, plastic
valualumiini, muovi
barwione aluminium, plastik

42 Anthrazit · anthracite

Incl. 1 x LED E27, 5 W
400 lm, 3.000 K

IP44

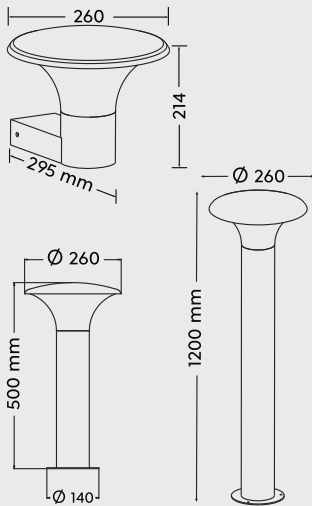

220160142



420160142



520160142

Incl. LED E27, 5 W
400 lm, 3.000 K



986-60



AMUR

Aluminium Druckguss, Kunststoff
diecast aluminium, plastic
fonte d'aluminium, plastique
gegoten aluminium, kunststof
aluminio fundido, plástico
pressofusione di alluminio, plastica
fonta aluminiu, plastic
valualumiini, muovi
barwione aluminium, plastik

31 Weiß matt · white mat

88 Silber antik · antique silver

Excl. 1 x E27, max. 60 W



IP44

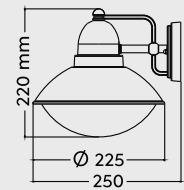

227460188



227460131

Empfohlen:
recommended:

LED E27, 6 W
470 lm, 3.000 K



987-60

NORMAN

Aluminium Druckguss, Acryl
diecast aluminium, acryl
fonte d'aluminium, acryl
gegoten aluminium, acryl
aluminio fundido, acrílico
pressofusione di alluminio, acrilico
fonta aluminiu, acrilic
valualumiini, akryyli
barwione aluminium, akryl

24 rostfarbig · rusty

31 Weiß matt · white mat

42 Anthrazit · anthracite

Excl. 1 x E27, max. 40 W

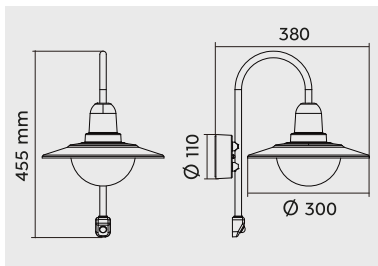

207269131



207269142

Empfohlen:
recommended:

LED E27, 6 W
470 lm, 3.000 K



987-60

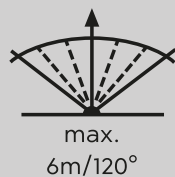

Bewegungssensor
Motion sensor
Détecteur de mouvement
Bewegingssensor
Sensor de movimiento
Sensore di movimento
Senzor de mişcare
Liiketunnistin
Czujnik ruchu



207269124

COOPER

Edelstahl, Kunststoff
steel, plastic
acier, plastique
staal, kunststof
acero, plástico
acciaio, plastica
inox, plastic
teräs, muovi
stal, plastik

42 Anthrazit · anthracite

Excl. 1 x E27, max. 40 W



IP44

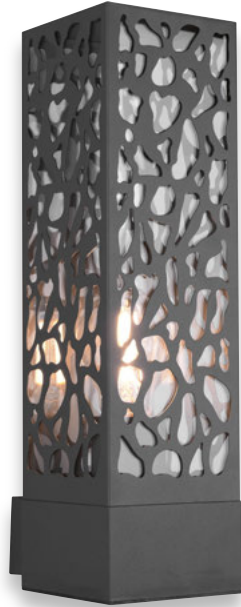

207360142

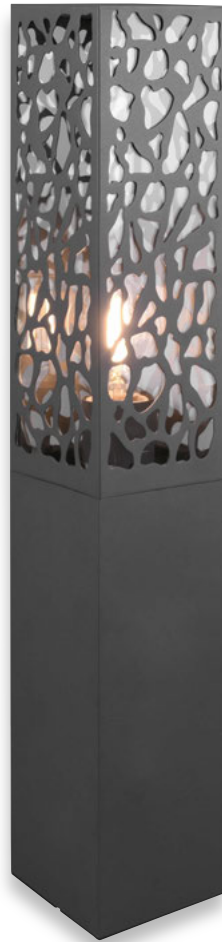

507360142



407360142

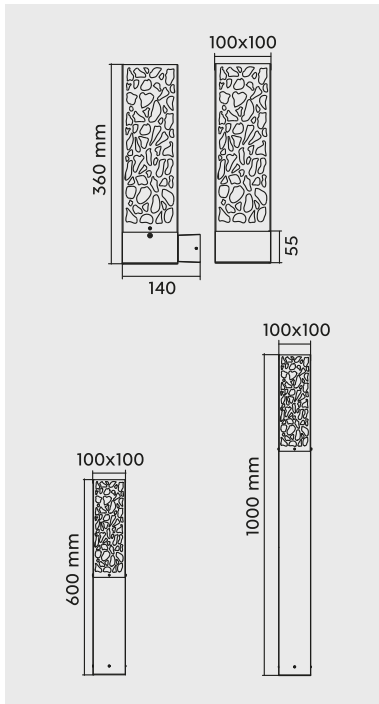

Empfohlen:
recommended:

LED E27, 6 W
470 lm, 3.000 K



987-400





CANNING

Aluminium Druckguss, Naturholz
 diecast aluminium, natural wood
 fonte d'aluminium, bois naturel
 gegoten aluminium, natuur hout
 aluminio fundido, madera natural
 pressofusione di alluminio, legno naturale
 fonta aluminiu, lemn natural
 valualumiini, luonnonpuu
 barwione aluminium, drewno naturalne

30 holzfarbig / Anthrazit ·
 wood coloured / anthracite

Excl. 1 x GU10, max. 28 W



IP44

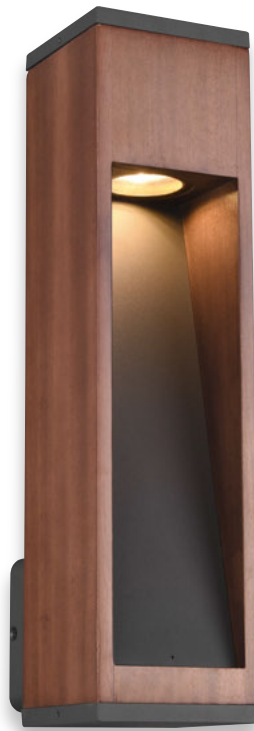
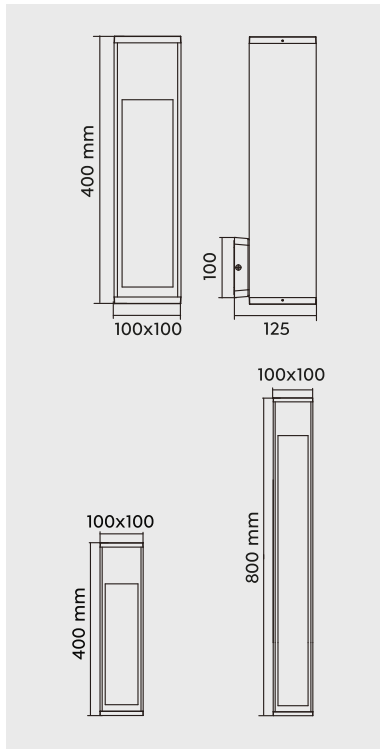

209660130



409660130

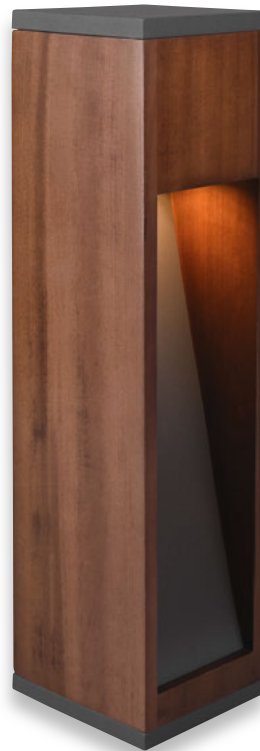

509660130

Empfohlen:
 recommended:

LED GU10, 5 W
 400 lm, 3.000 K
 ≥ 120°



955-50





GARONNE

Aluminium Druckguss,
Naturholz, Glas
diecast aluminium,
natural wood, glass
fonte d'aluminium,
bois naturel, verre
gegoten aluminium,
natuur hout, glas
aluminio fundido,
madera natural, vidrio
pressofusione di alluminio,
legno naturale, vetro
fonta aluminiu,
lemn natural, sticla
valualumiini,
luonnonpuu, lasi
barwione aluminium,
drewno naturalne, szkło

30 holzfarbig / Anthrazit ·
wood coloured / anthracite

Excl. 1 x E27, max. 40 W



IP44

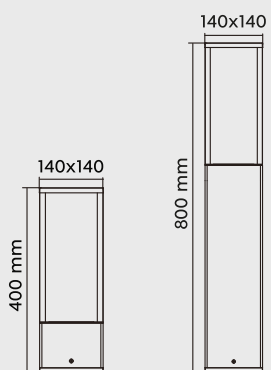
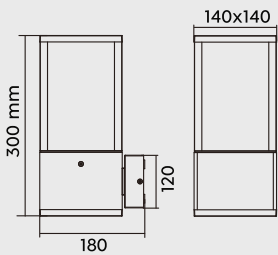

201860130



501860130



401860130

Empfohlen:
recommended:

Filament LED
E27, 4 W
400 lm, 2.700 K



987-400





GARONNE

Aluminium Druckguss, Glas
 diecast aluminium, glass
 fonte d'aluminium, verre
 gegoten aluminium, glas
 aluminio fundido, vidrio
 pressofusione di alluminio, vetro
 fonta aluminiu, sticla
 valualumiini, lasi
 barwione aluminium, szkło

42 Anthrazit · anthracite

Excl. 1 x E27, max. 40 W

201860142

401860142

501860142

Excl. 2 x E27, max. 40 W

201860242

601860242



IP44



601860242



201860142



201860242



401860142



501860142

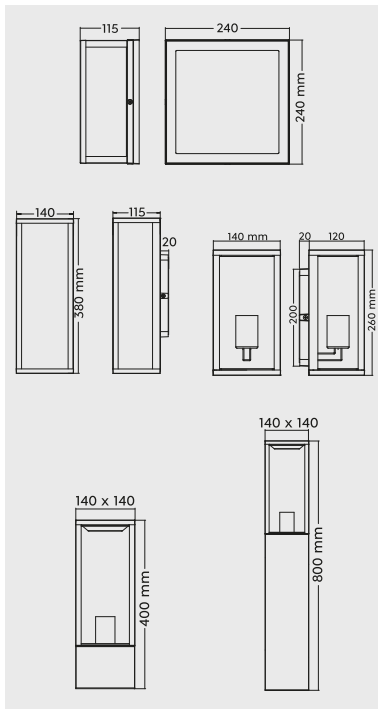

Empfohlen:
 recommended:

Filament LED
 E27, 6 W
 600 lm, 3.000 K



987-600

Empfohlen:
 recommended:

Filament LED
 E27, 4 W
 400 lm, 2.700 K



987-400





GARONNE

Aluminium Druckguss, Glas
 diecast aluminium, glass
 fonte d'aluminium, verre
 gegoten aluminium, glas
 aluminio fundido, vidrio
 pressofusione di alluminio, vetro
 fonta aluminiu, sticla
 valualumiini, lasi
 barwione aluminium, szkło

86 zinkfarbig · zinc-colored

Excl. 1 x E27, max. 40 W

201860186

401860186

501860186

Excl. 2 x E27, max. 40 W

201860286

601860286



IP44



601860286



201860186



201860286



401860186



501860186

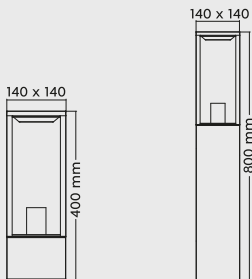
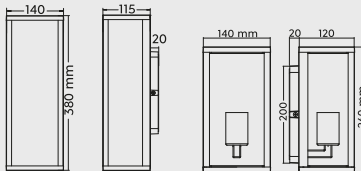
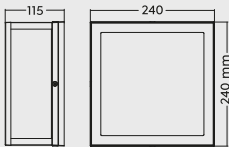

Empfohlen:
 recommended:

Filament LED
 E27, 6 W
 600 lm, 3.000 K



987-600

Empfohlen:
 recommended:

Filament LED
 E27, 4 W
 400 lm, 2.700 K



987-400



SAMBESI

Aluminium Druckguss, Acryl
diecast aluminium, acryl
fonte d'aluminium, acryl
gegoten aluminium, acryl
aluminio fundido, acrílico
pressofusione di alluminio, acrilico
fonta aluminiu, acrilic
valualumiini, akryyli
barwione aluminium, akryl

42 Anthrazit · anthracite

Excl. 1 x E27, max. 28 W

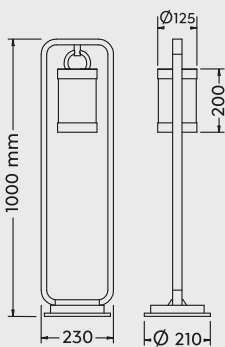
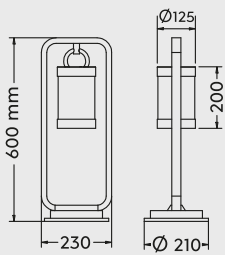
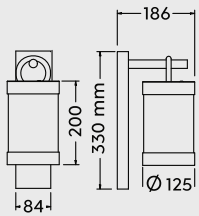

204160142



504160142

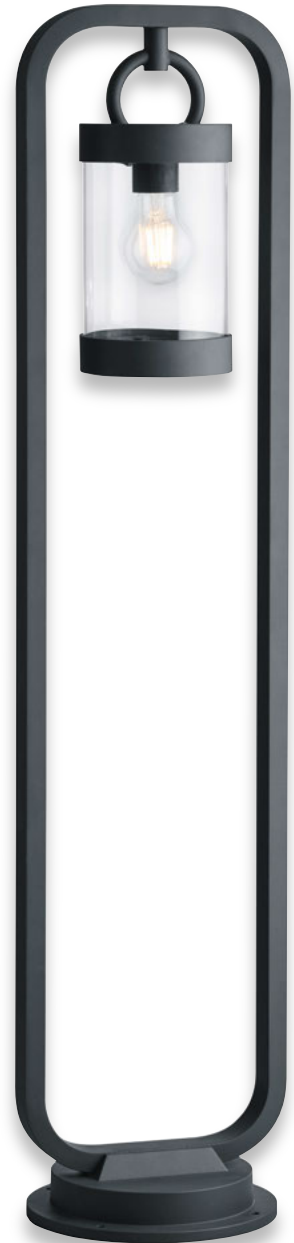

404160142

Empfohlen:
recommended:

Filament LED
E27, 4 W
400 lm, 3.000 K



987-400



Dämmerungssensor per Schalter deaktivierbar

On and off switchable dusk sensor

Détecteur de crépuscule commutable

Aan en uit schakelbare schemeringsensor

Sensor de oscuridad conmutable on/off

Sensore crepuscolare commutabile on/off

senzor de lumina/amurg on/off

On/off kytkettävä hämärätunnistin

Czujnik zmierzchowy dezaktywowany przez przełącznika

Aç-kapa anahtarlı karanlık sensörü

SAMBESI

Aluminium Druckguss, Acryl
diecast aluminium, acryl
fonte d'aluminium, acryl
gegoten aluminium, acryl
aluminio fundido, acrílico
pressofusione di alluminio, acrilico
fonta aluminiu, acrilic
valualumiini, akryyli
barwione aluminium, akryl

31 Weiß matt · white mat

Excl. 1 x E27, max. 28 W

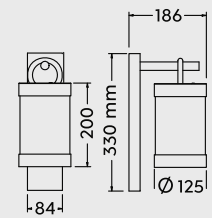

204160131

Empfohlen:
recommended:

Filament LED
E27, 4 W
400 lm, 3.000 K



987-400

SAMBESI

Aluminium Druckguss, Acryl
 diecast aluminium, acryl
 fonte d'aluminium, acryl
 gegoten aluminium, acryl
 aluminio fundido, acrílico
 pressofusione di alluminio, acrilico
 fonta aluminiu, acrilic
 valualumiini, akryyli
 barwione aluminium, akryl

24 rostfarbig · rusty

Excl. 1 x E27, max. 28 W



204160124

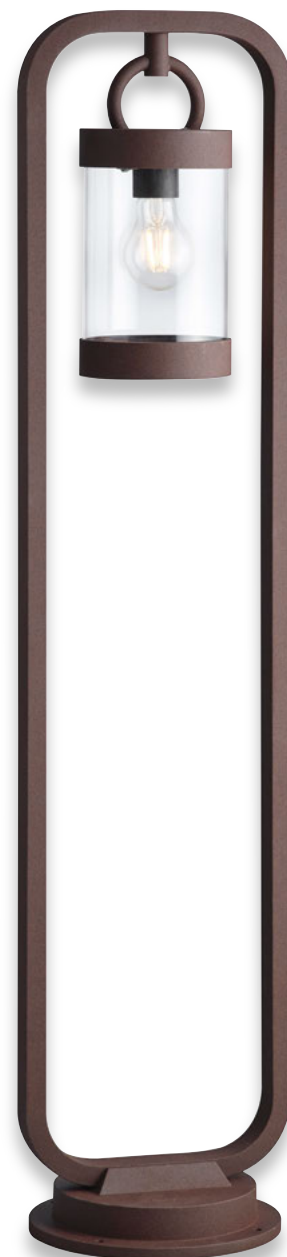

404160124



504160124

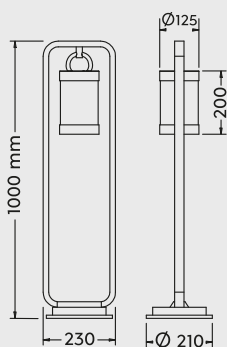
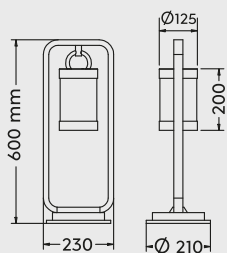
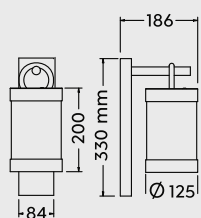

Empfohlen:
 recommended:

Filament LED
 E27, 4 W
 400 lm, 3.000 K



987-400

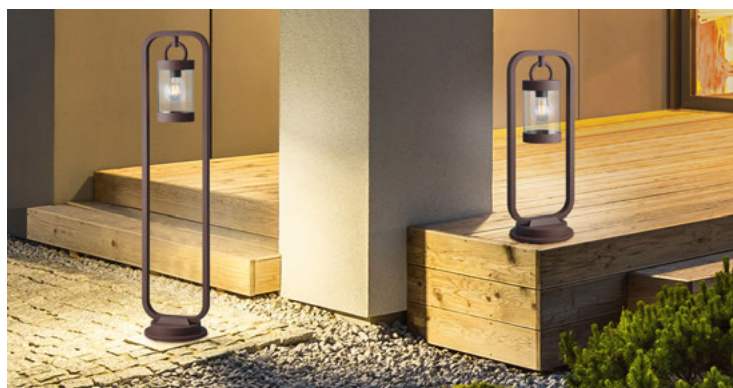



Dämmerungssensor per Schalter deaktivierbar

On and off switchable dusk sensor

Détecteur de crépuscule commutable

Aan en uit schakelbare schemeringsensor

Sensor de oscuridad conmutable on/off

Sensore crepuscolare commutabile on/off

senzor de lumina/amurg on/off

On/off kytkettävä hämärätunnistin

Czujnik zmierzchowy dezaktywowany przez przełącznika

Aç-kapa anahtarlı karanlık sensörü



SAMBESI

Aluminium Druckguss, Kunststoff
 diecast aluminium, plastic
 fonte d'aluminium, plastique
 gegoten aluminium, kunststof
 aluminio fundido, plástico
 pressofusione di alluminio, plastica
 fonta aluminiu, plastic
 valualumiini, muovi
 barwione aluminium, plastik

24 rostfarbig · rusty
31 Weiß matt · white mat
42 Anthrazit · anthracite

Excl. 1 x E27, max. 28 W

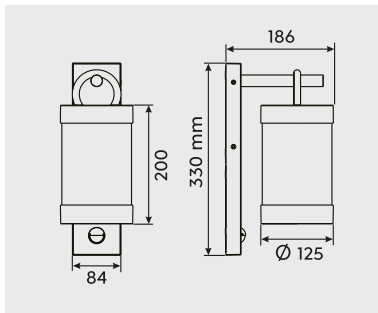

204169131



204169124

Empfohlen:
 recommended:

Filament LED
 E27, 4 W
 400 lm, 3.000 K



987-400

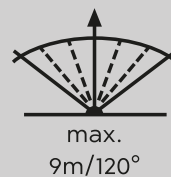

Bewegungssensor
 Motion sensor
 Détecteur de mouvement
 Bewegungssensor
 Sensor de movimiento
 Sensore di movimento
 Senzor de mișcare
 Liiketunnistin
 Czujnik ruchu



204169142

TANARO

Aluminium Druckguss, Acryl
diecast aluminium, acryl
fonte d'aluminium, acryl
gegoten aluminium, acryl
aluminio fundido, acrílico
pressofusione di alluminio, acrilico
fonta aluminiu, acrilic
valualumiini, akryyli
barwione aluminium, akryl

42 Anthrazit · anthracite

Excl. 1 x E27, max. 40 W

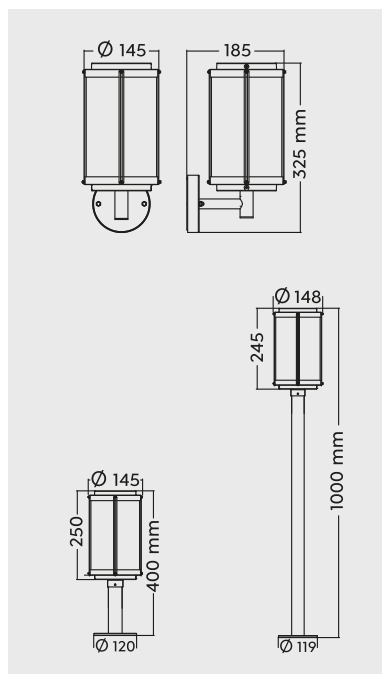

502360142



402360142

Empfohlen:
recommended:

Filament LED
E27, 4 W
400 lm, 3.000 K



987-400





202360142

TANARO

Aluminium Druckguss, Acryl
diecast aluminium, acryl
fonte d'aluminium, acryl
gegoten aluminium, acryl
aluminio fundido, acrílico
pressofusione di alluminio, acrilico
fonta aluminiu, acrilic
valualumiini, akryyli
barwione aluminium, akryl

24 rostfarbig · rusty

Excl. 1 x E27, max. 40 W



IP44

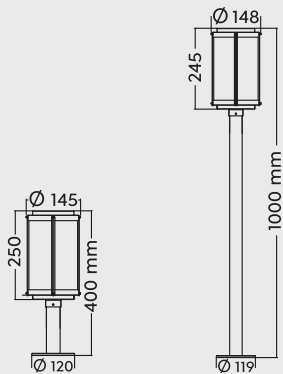
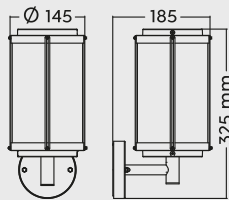

202360124



502360124



402360124

Empfohlen:
recommended:

Filament LED
E27, 4 W
400 lm, 3.000 K





BRENTA

Aluminium Druckguss, Glas
diecast aluminium, glass
fonte d'aluminium, verre
gegoten aluminium, glas
aluminio fundido, vidrio
pressofusione di alluminio, vetro
fonta aluminiu, sticla
valualumiini, lasi
barwione aluminium, szkło

24 rostfarbig · rusty

42 Anthrazit · anthracite

86 zinkfarbig · zinc-colored

Excl. 1 x E27, max. 40 W



IP44

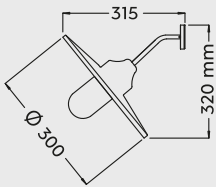

201760124



201760142



201760186

Empfohlen:
recommended:

Filament LED
E27, 4 W
400 lm, 3.000 K



987-400





BRENTA

Aluminium Druckguss, Glas
diecast aluminium, glass
fonte d'aluminium, verre
gegoten aluminium, glas
aluminio fundido, vidrio
pressofusione di alluminio, vetro
fonta aluminiu, sticla
valualumiini, lasi
barwione aluminium, szkło

24 rostfarbig · rusty

42 Anthrazit · anthracite

86 zinkfarbig · zinc-colored

Excl. 1 x E27, max. 40 W



IP44

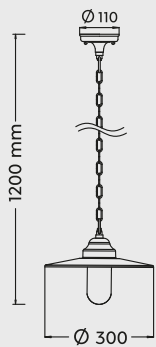

301760124



301760142



301760186

Empfohlen:
recommended:

Filament LED
E27, 4 W
400 lm, 3.000 K



987-400

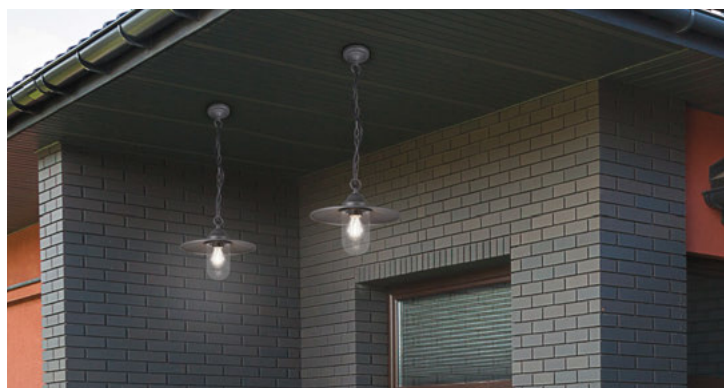



OLONA

Aluminium Druckguss, Glas
diecast aluminium, glass
fonte d'aluminium, verre
gegoten aluminium, glas
aluminio fundido, vidrio
pressofusione di alluminio, vetro
fonta aluminiu, sticla
valualumiini, lasi
barwione aluminium, szkło

24 rostfarbig · rusty

42 Anthrazit · anthracite

Excl. 1 x E27, max. 20 W



IP23

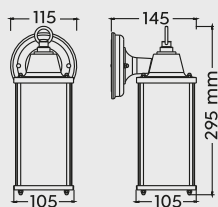

201960124



201960142

Empfohlen:
recommended:

Filament LED
E27, 4 W
400 lm, 3.000 K



987-400



ARKANSAS

Aluminium Druckguss, Glas
diecast aluminium, glass
fonte d'aluminium, verre
gegoten aluminium, glas
aluminio fundido, vidrio
pressofusione di alluminio, vetro
fonta aluminiu, sticla
valualumiini, lasi
barwione aluminium, szkło

24 rostfarbig · rusty

42 Anthrazit · anthracite

Excl. 1 x E27, max. 40 W



IP23

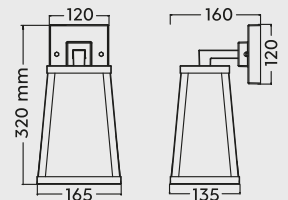

201360142

201360124

Empfohlen:
recommended:

Filament LED
E27, 4 W
400 lm, 3.000 K



987-400

GRACHT

Aluminium Druckguss, Acryl
diecast aluminium, acryl
fonte d'aluminium, acryl
gegoten aluminium, acryl
aluminio fundido, acrílico
pressofusione di alluminio, acrilico
fonta aluminiu, acrilic
valualumiini, akryyli
barwione aluminium, akryl

28 rostfarbig antik · antique rust

Incl. 1 x SMD-LED, 6 W
650 lm, 3.000 K

IP54

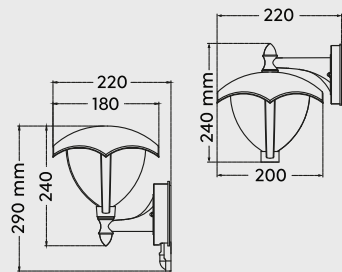

221967128



221969128

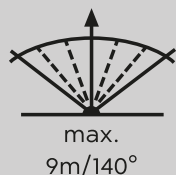

Bewegungssensor
Motion sensor
Décteur de mouvement
Bewegingssensor
Sensor de movimiento
Sensore di movimento
Senzor de mişcare
Liiketunnistin
Czujnik ruchu



DUERO

Aluminium Druckguss, Glas
diecast aluminium, glass
fonte d'aluminium, verre
gegoten aluminium, glas
aluminio fundido, vidrio
pressofusione di alluminio, vetro
fonta aluminiu, sticla
valualumiini, lasi
barwione aluminium, szkło

24 rostfarbig · rusty

42 Anthrazit · anthracite

78 betonfarbig · concrete look

Excl. 1 x E27, max. 40 W



IP44

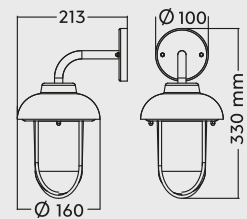

202760142

202760124

202760178

Empfohlen:
recommended:

Filament LED
E27, 4 W
400 lm, 3.000 K



987-400

KELLY

Aluminium Druckguss, Glas
diecast aluminium, glass
fonte d'aluminium, verre
gegoten aluminium, glas
aluminio fundido, vidrio
pressofusione di alluminio, vetro
fonta aluminiu, sticla
valualumiini, lasi
barwione aluminium, szkło

31 Weiß matt · white mat

42 Anthrazit · anthracite

Incl. 1 x SMD-LED, 9 W
900 lm, 3.000 K

IP44

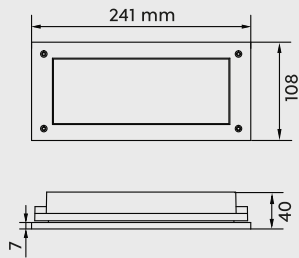

251060131



251060142



HARDEY



Aluminium Druckguss, Glas
diecast aluminium, glass
fonte d'aluminium, verre
gegoten aluminium, glas
aluminio fundido, vidrio
pressofusione di alluminio, vetro
fonta aluminiu, sticla
valualumiini, lasi
barwione aluminium, szkło

31 Weiß matt · white mat

42 Anthrazit · anthracite

Incl. 1 x SMD-LED, 9 W
900 lm, 3.000 K

IP44

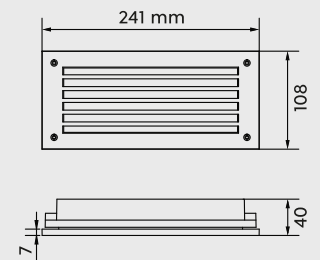

251160142



251160131

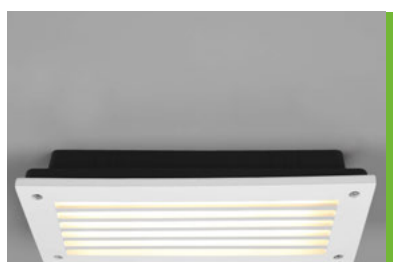

Bodeneinbaustrahler
 Recessed floor lamps
 Luminaires encastrés de sol
 grond inbouwspot
 Lámparas de pie empotradas
 Incasso Calpestabili
 Lampi incastrate in podea
 upotetut maavalot
 wpuszczone lampy podłogowe

07 Nickel matt · nickel mat

Incl. 1 x SMD-LED, 3 W
 180 lm, 3.000 K

IP65

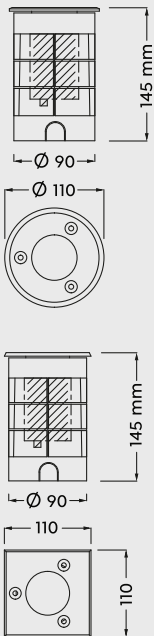

821660107



821669107



Abstrahlwinkel
 Emission angle
 Angle de rayonnement
 Uitstraalhoek
 Ángulo de emisión
 Angolo di emissione
 Unghiul de emisii
 Säteilukulma
 Kąt emisji



Belastbarkeit
 Resilience
 Limite de charge
 Belastbaarheid
 Resistencia
 Resistenza
 Rezistența la solicitare
 Kuormitettavuus
 Nośność



Bodeneinbaustrahler
 Recessed floor lamps
 Luminaires encastrés de sol
 grond inbouwspot
 Lámparas de pie empotradas
 Incasso Calpestabili
 Lampi incastrate in podea
 upotetut maavalot
 wpuszczone lampy podłogowe

07 Nickel matt · nickel mat

Incl. 1 x SMD-LED, 9 W
 540 lm, 3.000 K

IP65

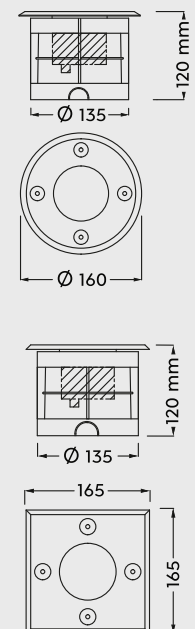

821660207



Abstrahlwinkel
 Emission angle
 Angle de rayonnement
 Uitstraalhoek
 Ángulo de emisión
 Angolo di emissione
 Unghiul de emisii
 Säteilykulma
 Kąt emisji



Belastbarkeit
 Resilience
 Limite de charge
 Belastbaarheid
 Resistencia
 Resistenza
 Rezistența la solicitare
 Kuormitettavuus
 Nośność



821669207

NECTOR

Kunststoff
 plastic
 plastique
 kunststof
 plástico
 plastica
 plastic
 muovi
 plastik

01 Weiß · white

Incl. RGBW-LED, 8,5 W
 600 lm, 3.000 - 5.500 K

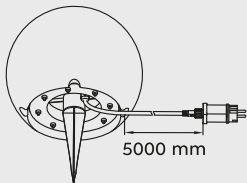
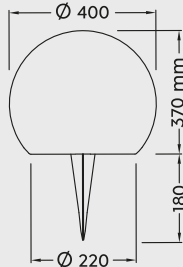
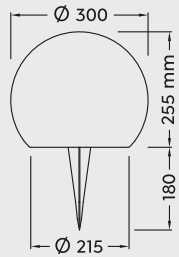

551753001



551754001



+



64.000 **WEISSTÖNE**
 64,000 **WHITES**



Voreingestellte Lichtmodi · Preset light modes



16 Millionen **FARBEN**
 16 million **COLORS**



Dynamische Lichtmodi · Dynamic light modes



WIZ
 CONNECTED

trio-lighting.com/wiz

Get your light connected.



WiZ
APP



Wlan Technologie
WiFi technology



WiZ
MOTE

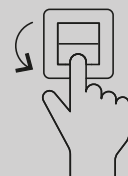

WiZ
CLICK

UBANGI

Aluminium Druckguss
diecast aluminium
fonte d'aluminium
gegoten aluminium
aluminio fundido
pressofusione di alluminio
fonta aluminiu
valualumiini
barwione aluminium

42 Anthrazit · anthracite

Excl. 1 x GU10, max. 28 W



IP65



800260142

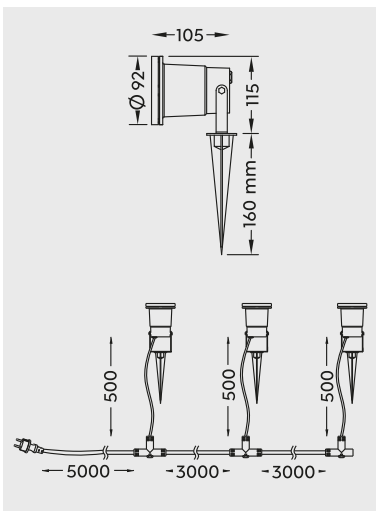

800260342
3er Set/3 pc.

Empfohlen:
recommended:

LED GU10, 5 W
400 lm, 3.000 K
≥ 120°



955-50





GARTENSTECKDOSEN · GARDEN SOCKETS

Polyresin
polyresin
polyresin
polyresin
poliresina
poliestere
polirasina
polyresiini
polyresin

11 Grau · grey

Zeitschaltuhr · timer
max. 3.600 W

9961-11



max. 3.600 W

9962-11

9963-11



9961-11



9962-11

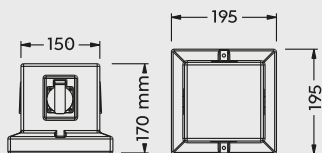
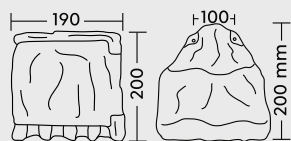

9963-11





9964-42

Aluminium Druckguss
diecast aluminium
fonte d'aluminium
gegooten aluminium
aluminio fundido
pressofusione di alluminio
fonta aluminii
valualumiini
barwione aluminium

42 Anthrazit · anthracite

max. 3.600 W

IP44

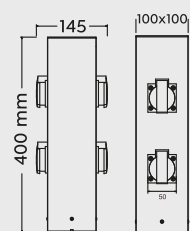

x 4



UNIVERSAL-ERDSPIESS · GROUND SPIKE

Erdspieß, Edelstahl
Ground spike, steel
Piquet de terre, acier
Aardingspin, staal
Espiga, acero
Picchetto, acciaio
Țepușă pentru pământ, inox
Maapiikki, teräs
Žerdz, stal

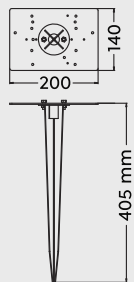

9960-07

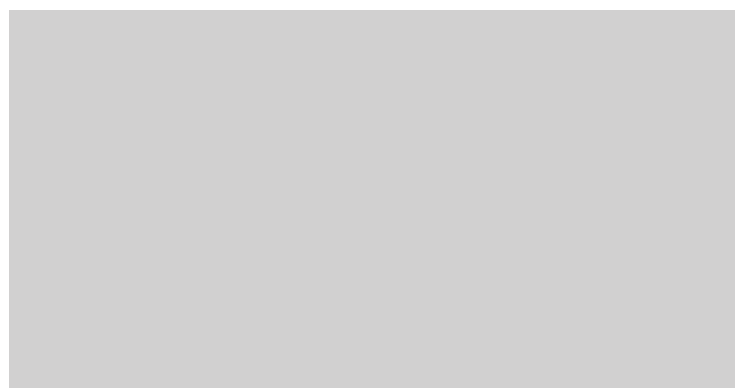
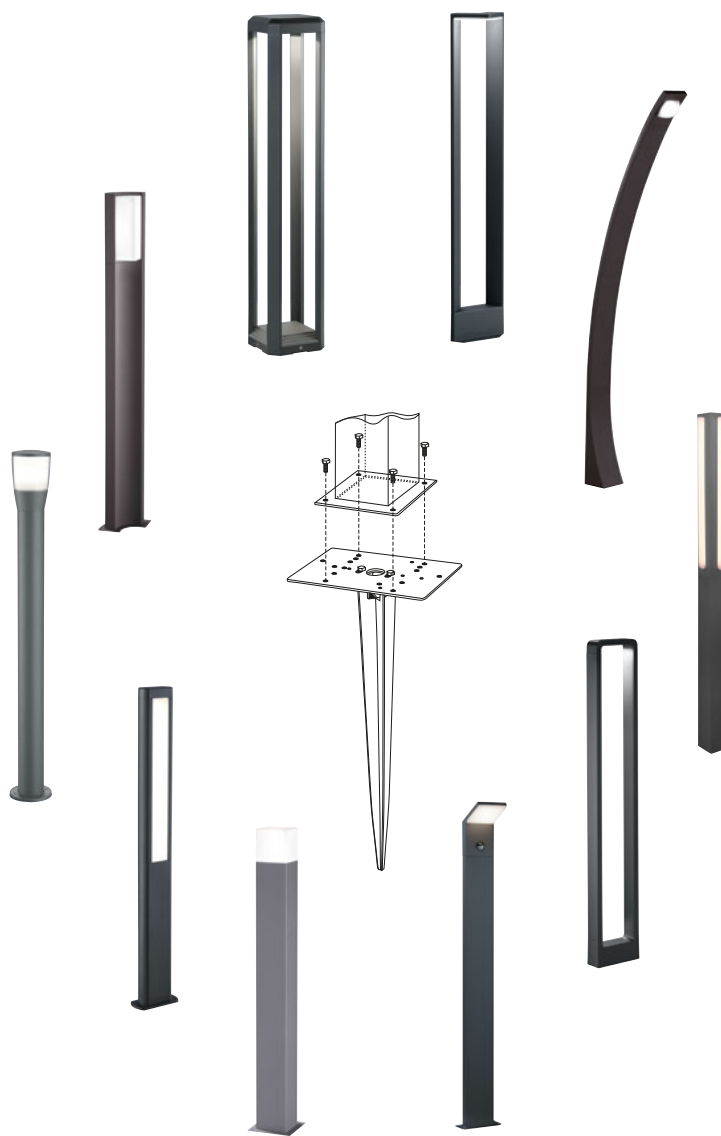

ECKBEFESTIGUNG · CORNER FASTENING

Eckbefestigung, Kunststoff
Corner fastening, plastic
Montage en angle, plastique
Hoekbevestiging, kunststof
Cantонера, plástico
Montaggio ad angolo, plastica
Fixare pentru colț, plastic
Kulmakiinnike, muovi
Okucie narożne, plastik

32 Schwarz matt · black mat

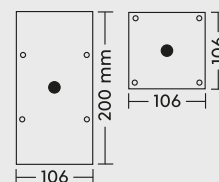

9965-32

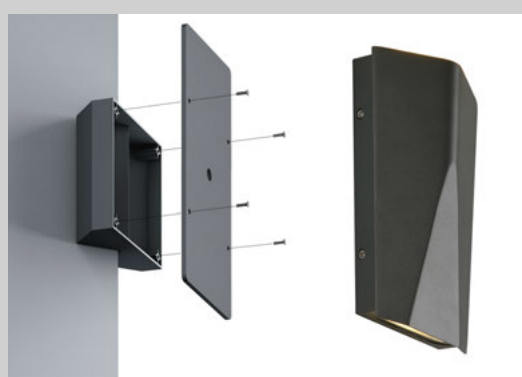
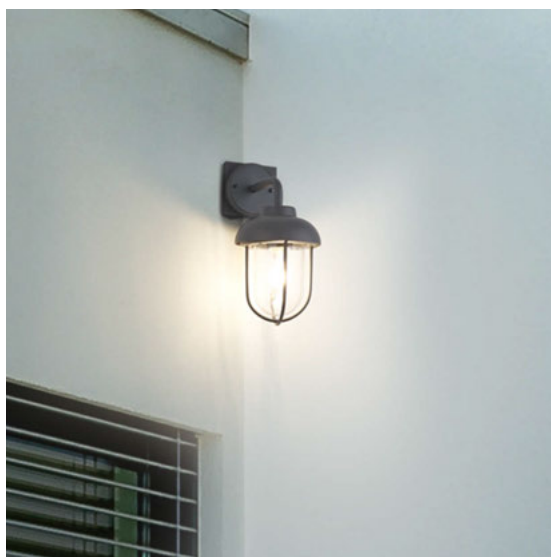
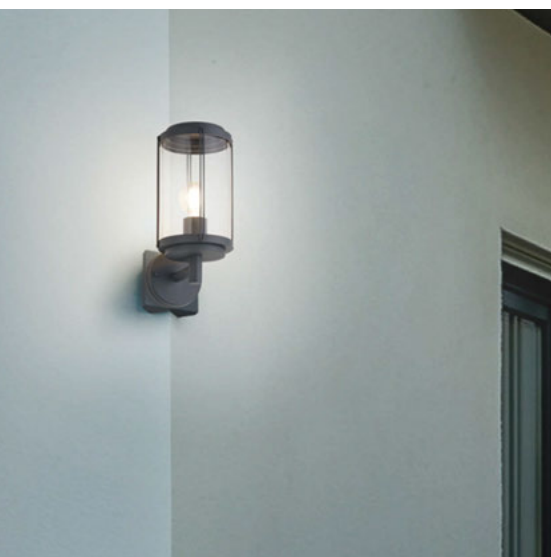





ARACATI

Nickel matt, Acryl
nickel mat, acryl
nickel mat, acryl
nikkel mat, acryl
níquel mate, acrílico
nichel opaco, acrilico
nichel mat, acrilic
harjattu teräs, akryyli
nikiel mat, akryl

07 Nickel matt · nickel mat

Incl. 1 x SMD-LED, 4 W
340 lm, 3.000 K

R28211107

IP44

Incl. 2 x SMD-LED, 4 W
2 x 340 lm, 3.000 K

R28212107

IP44

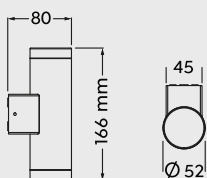
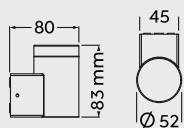

R28211107



R28212107





CORDOBA

Kunststoff
plastic
plastique
kunststof
plástico
plastica
plastic
muovi
plastik

31 Weiß matt · white mat

32 Schwarz matt · black mat

Incl. 2 x SMD-LED, 2 W
2 x 200 lm, 3.000 K



R28222631



R28222632

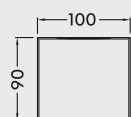
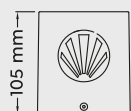

ROSARIO



R28232631

Kunststoff
plastic
plastique
kunststof
plástico
plastica
plastic
muovi
plastik

- 31** Weiß matt · white mat
- 32** Schwarz matt · black mat

Incl. 2 x SMD-LED, 2 W
2 x 200 lm, 3.000 K

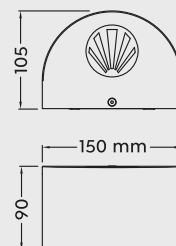

R28232632



BOGOTA

Aluminium Druckguss
diecast aluminium
fonte d'aluminium
gegoten aluminium
aluminio fundido
pressofusione di alluminio
fonta aluminii
valualumiini
barwione aluminium

42 Anthrazit · anthracite

Incl. 2 x SMD-LED, 3 W
2 x 260 lm, 3.000 K

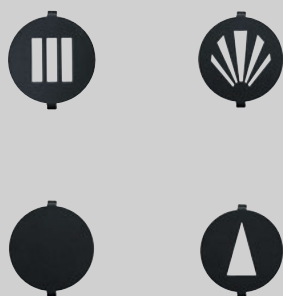
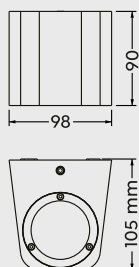

MOLINA

Aluminium Druckguss, Kunststoff
diecast aluminium, plastic
fonte d'aluminium, plastique
gegoten aluminium, kunststof
aluminio fundido, plástico
pressofusione di alluminio, plastica
fonta aluminiu, plastic
valualumiini, muovi
barwione aluminium, plastik

42 Anthrazit · anthracite

Incl. 2 x SMD-LED, 4,6 W
2 x 550 lm, 3.000 K

IP54

R22052142



R22062142

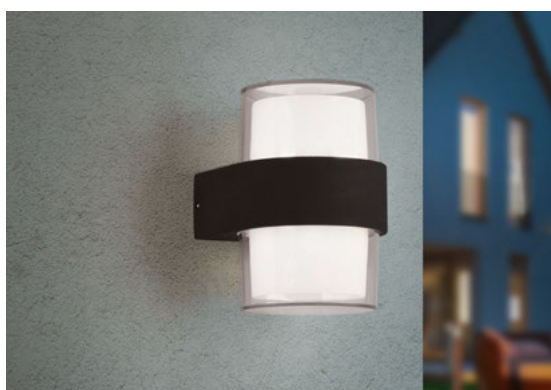
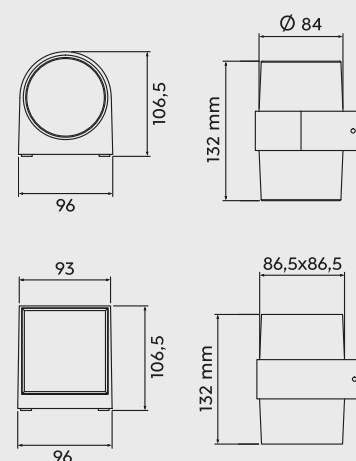

KENDAL

Kunststoff
 plastic
 plastique
 kunststof
 plástico
 plastica
 plastic
 muovi
 plastik

31 Weiß matt · white mat

42 Anthrazit · anthracite

Incl. SMD-LED, 12 W
 1.200 lm, 3.000 K

R22151131

R22151142

IP54

Incl. SMD-LED, 12 W
 1.000 lm, 3.000 K

R62151131

R62151142

IP54



R62151131



R62151142



R22151131



R22151142

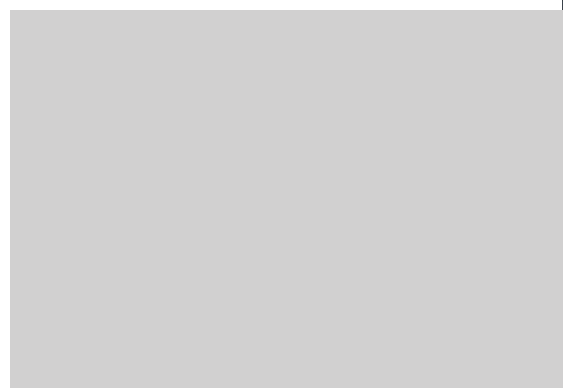
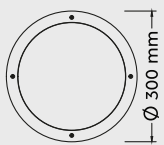



CAMARO

Kunststoff
plastic
plastique
kunststof
plástico
plastica
plastic
muovi
plastik

31 Weiß matt · white mat

42 Anthrazit · anthracite

Excl. 1 x E27, max. 12 W

R60501031

R60501042

Excl. 2 x E27, max. 12 W

R60502031

R60502042



IP54

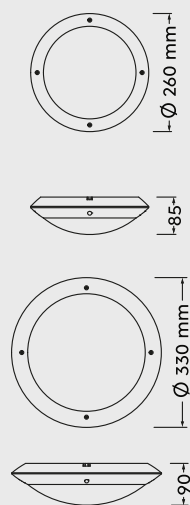

R60501031



R60501042



R60502031



R60502042

Empfohlen:
recommended:

LED E27, 5 W
400 lm, 3.000 K



986-60







Außenbeleuchtung ist viel mehr als nur funktional!

Dank integriertem Akku sind die transportablen Leuchten flexibel und setzen spannende Akzente im Garten, auf dem Balkon oder der Terrasse - ganz ohne Kabel! Für die richtige Stimmung sorgen zusätzliche Highlights wie RGB-Farbwechsler oder Bluetooth-Funktion für kabelloses Musik hören. Die perfekte Beleuchtung für gemeinsame Abendstunden mit Familie und Freunden.

Outdoor lighting is much more than just functional!

Integrated rechargeable batteries lets you flexibly use these easily transportable lights to accent your garden, balcony or terrace in an exciting way, all without any cables! Additional highlights like an RGB colour wheels and Bluetooth for streaming music wirelessly provide just the right mood. The perfect lighting for spending evening hours with family and friends.

L'éclairage extérieur est bien plus que simplement fonctionnel !

Grâce à la batterie rechargeable intégrée, les lampes transportables sont flexibles et mettent des accents excitants dans le jardin, sur le balcon ou la terrasse –

sans aucun câble ! D'autres fonctions marquantes garantissent une bonne ambiance, telles que le changeur de couleurs RVB ou la fonction Bluetooth pour l'écoute de musique sans fil. L'éclairage parfait pour les soirées partagées avec la famille et les amis.

Buitenverlichting is veel meer dan enkel nuttig!

Dankzij de geïntegreerde accu zijn de verplaatsbare lampen flexibel en zorgen voor mooie accenten in de tuin, op het balkon of op het terras, en dat helemaal zonder kabel! Voor de juiste stemming zorgen extra hoogtepunten zoals de RGB-kleurenwisselaar of Bluetooth-functie om draadloos muziek te beluisteren. De perfecte verlichting om 's avonds aangenaam te vertoeven met vrienden en familie.

¡La iluminación exterior es mucho más que algo funcional!

Gracias a la batería integrada, las luces transportables son flexibles y aportan puntos de atención excitantes al jardín, al balcón o a la terraza - ¡y sin ningún tipo de cables! Se consigue el ambiente adecuado con otras características especiales adicionales como el modificador de color RGB o la función Bluetooth para escuchar música sin cables. La iluminación perfecta para pasar la tarde con la familia y los amigos.



L'illuminazione esterna è molto più che funzionale!

Grazie alla batteria ricaricabile integrata, le lampade portatili sono flessibili e creano accenti emozionanti in giardino, sul balcone o sulla terrazza - senza cavi! Ulteriori punti di forza come il cambiacolori RGB o la funzione Bluetooth per l'ascolto di musica senza fili assicurano il giusto feeling. L'illuminazione perfetta per le ore serali da trascorrere insieme alla famiglia e agli amici.

Iluminarea exterioară este mult mai mult decât funcțională!

Datorită acumulatorului integrat, lămpile transportabile sunt flexibile și oferă un aspect atrăgător în grădină, pe balcon sau pe terasă - fără cablu! Atmosfera potrivită este asigurată de jocurile suplimentare de lumină cum ar fi schimbarea culorilor RGB sau funcția Bluetooth pentru a asculta muzică fără cablu. Iluminarea perfectă pentru orele de seară cu familia și prietenii.

Ulkovalaistus on paljon muutakin kuin vain toimintaa!

Integroidun ladattavan akun ansiosta siirrettävät valaisimet ovat joustavia ja muodostavat jännittäviä korostuksia puutarhaan, parvekkeelle tai terassille - ilman kaapeleita! Lisäkorostukset, kuten RGB-väinvaihtajat tai Bluetooth-toiminto langattomaan musiikin kuuntelun, takaavat oikean ilmapiirin. Täydellinen valaistus illanviettoon yhdessä perheen ja ystävien kanssa.

Oświetlenie zewnętrzne to znacznie więcej niż tylko funkcjonalność!

Dzięki akumulatorowi przenośne lampy są elastyczne w ustawieniu i tworzą ekscytujące akcenty w ogrodzie, na balkonie lub tarasie - bez żadnych kabli! Odpowiedni nastrój zapewnią dodatkowe urządzenia, takie jak zmienne kolorów RGB lub funkcja Bluetooth do bezprzewodowego słuchania muzyki. Doskonałe oświetlenie wspólnych wieczorów z rodziną i przyjaciółmi.

PALMAS

Kunststoff
plastic
plastique
kunststof
plástico
plastica
plastic
muovi
plastik

01 Weiß · white

Incl. 1 x RGBW-LED, 1,5 W
45 lm, 3.000 K

R55101101

Incl. 1 x RGBW-LED, 3 W
90 lm, 3.000 K

R45101101

Incl. 1 x RGBW-LED, 4,5 W
120 lm, 3.000 K

R45101901

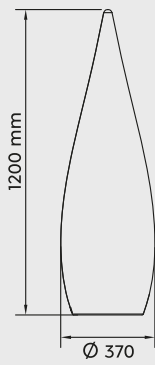
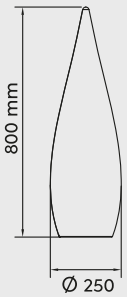

R55101101



R45101101



R45101901



RGBW Farbwechsler
RGBW Colorchanging
Changement de couleur RGBW
RGBW Kleurverandering
Cambio de color RGBW
Cambia colore RGBW
Schimbator de culoare RGBW
Värinvaihto RGB
Zmieniający kolor RGBW



Akkubetrieb
Rechargeable battery operated
Fonctionnement sur batteries rechargeable
Oplaadbare accu
Batería recargable
Batteria Ricaricabile
Operabil prin baterie reincarcabila
Ladattava akku
Akumulator zasilany bateryjnie
Şarj edilebilir pilli



Ladezeit
Charging time
Temps de charge
Oplaaftijd
Tiempo de carga
Tempo di carica
Timp de incarcare
Latausaika
Czas ładowania



Leuchtdauer
Luminous period
Durée d'éclairage
Brandtijd
Tiempo de iluminación
Tempo di durata
Perioada de iluminare
Valaistusaika
Czas świecenia

BERMUDA

Kunststoff
plastic
plastique
kunststof
plástico
plastica
plastic
muovi
plastik

01 Weiß · white

Incl. 1 x RGBW-LED, 1 W
35 lm, 3.000 K

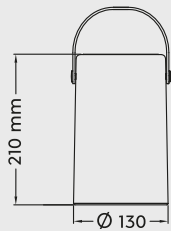

LIGHT & SOUND



R55060101



Bluetooth Lautsprecher
Bluetooth loudspeaker
Haut-parleur bluetooth
Bluetooth luidspreker
Altavoz de bluetooth
Altoparlante bluetooth
Difuzor Bluetooth
Bluetooth-kaiutin
Głośnik Bluetooth



Ladezeit
Charging time
Temps de charge
Oplaaadtijd
Tiempo de carga
Tempo di carica
Timp de incarcare
Latausaika
Czas ładowania



Leuchtdauer
Luminous period
Durée d'éclairage
Brandtijd
Tiempo de iluminación
Tempo di durata
Perioada de iluminare
Valaistusaika
Czas świecenia

JAMAICA

Kunststoff
plastic
plastique
kunststof
plástico
plastica
plastic
muovi
plastik

01 Weiß · white

Incl. 1 x RGBW-LED, 2,5 W
25 lm, 3.000 K

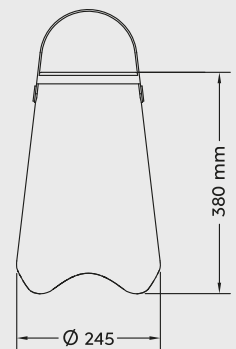

LIGHT & SOUND



R55086101

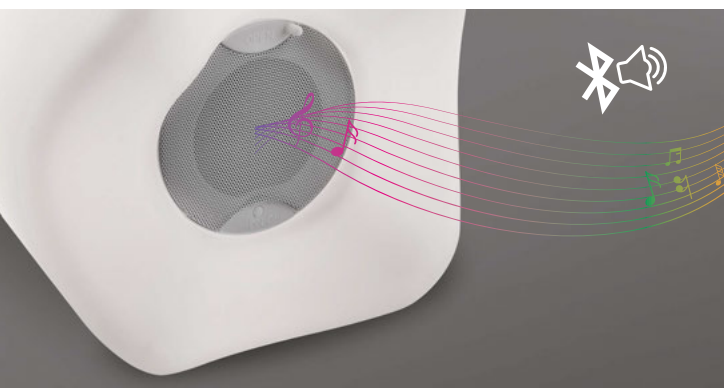

ARUBA

Kunststoff
plastic
plastique
kunststof
plástico
plastica
plastic
muovi
plastik

01 Weiß · white

Incl. 1 x RGBW-LED, 1 W
70 lm, 3.000 K

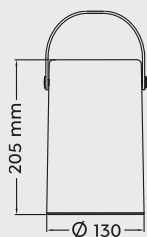

R57080101



RGBW Farbwechsler
RGBW Colorchanging
Changement de couleur RGBW
RGBW Kleurverandering
Cambio de color RGBW
Cambia colore RGBW
Schimbator de culoare RGBW
Värinvaihto RGB
Zmieniający kolor RGBW



USB Anschluss mit Ladefunktion
Recharging USB connection
Entrée USB de rechargement
Opladende USB aansluiting
Conexión USB de recarga
Connessione USB di ricarica
Conexiune USB reîncărcare
Lataaminen USB-liitäntä
Ładowania USB połączenie
șarj USB baġlantı

HAITI



R57090101

Kunststoff
plastic
plastique
kunststof
plástico
plastica
plastic
muovi
plastik

01 Weiß · white

Incl. 1 x RGBW-LED, 1 W
70 lm, 3.000 K



Ladezeit
Charging time
Temps de charge
Oplaadtijd
Tiempo de carga
Tempo di carica
Timp de incarcare
Latausaika
Czas ładowania



Leuchtdauer
Luminous period
Durée d'éclairage
Brandtijd
Tiempo de iluminación
Tempo di durata
Perioada de iluminare
Valaistusaika
Czas świecenia



HAWAII

Kunststoff
plastic
plastique
kunststof
plástico
plastica
plastic
muovi
plastik

01 Weiß · white

Incl. 1 x RGB-LED, 1,5 W
60 lm, 3.000 K

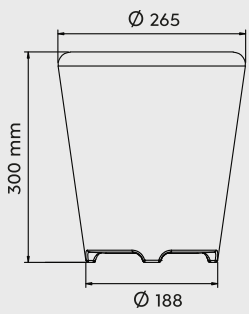
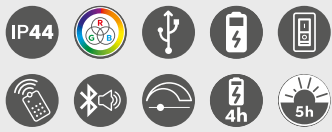

LIGHT & SOUND



R55096101



Bluetooth Lautsprecher
Bloutooth loudspeaker
Haut-parleur bluetooth
Bluetooth luidspreker
Altavoz de bluetooth
Altoparlante bluetooth
Difuzor Bluetooth
Bluetooth-kaiutin
Głośnik Bluetooth



Ladezeit
Charging time
Temps de charge
Oplaadtijd
Tiempo de carga
Tempo di carica
Timp de incarcare
Latausaika
Czas ładowania



Leuchtdauer
Luminous period
Durée d'éclairage
Brandtijd
Tiempo de iluminación
Tempo di durata
Perioada de iluminare
Valaistusaika
Czas świecenia

Kunststoff
plastic
plastique
kunststof
plástico
plastica
plastic
muovi
plastik

01 Weiß · white

Incl. 1 x SMD-LED, 1,5 W
130 lm, 3.000 K

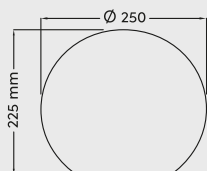
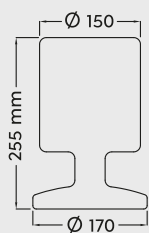

BARBADOS

R57010101



BAHAMAS

R57020101



Ladezeit
Charging time
Temps de charge
Oplaadtijd
Tiempo de carga
Tempo di carica
Timp de incarcare
Latausaika
Czas ładowania



Leuchtdauer
Luminous period
Durée d'éclairage
Brandtijd
Tiempo de iluminación
Tempo di durata
Perioada de iluminare
Valaistusaika
Czas świecenia



DORA
R57051101

LORA
R57071101

Kunststoff
plastic
plastique
kunststof
plástico
plastica
plastic
muovi
plastik

01 Weiß · white

Incl. 1 x SMD-LED, 1,5 W
90 lm, 3.000 K

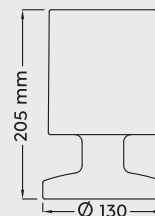
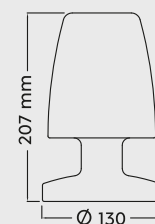

Akkubetrieb
Rechargeable battery operated
Fonctionnement sur batteries rechargeable
Oplaadbare accu
Batería recargable
Batteria Ricaricabile
Operabil prin baterie reincarcabila
Ladattava akku
Akumulator zasilany bateryjnie



USB Anschluss mit Ladefunktion
Recharging USB connection
Entrée USB de rechargement
Opladende USB aansluiting
Conexión USB de recarga
Connessione USB di ricarica
Conexiune USB reîncărcare
Lataaminen USB-liitäntä
Ładowania USB połączenie

DOMINGO

Metall, Kunststoff
 metal, plastic
 metale, plastique
 metaal, kunststof
 metal, plástico
 metallo, plastica
 metal, plastic
 metalli, muovi
 metal, plastik

42 Anthrazit · anthracite

Incl. 1 x SMD-LED, 2 W
 150 lm, 3.000 K

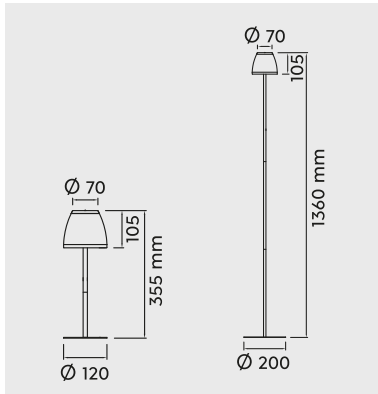

R52096142



R42096142

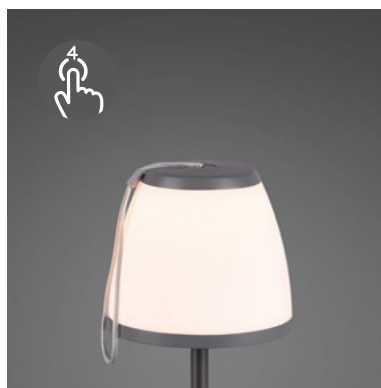

Ladezeit
 Charging time
 Temps de charge
 Oplaadtijd
 Tiempo de carga
 Tempo di carica
 Timp de încarcare
 Latausaika
 Czas ładowania



Leuchtdauer
 Luminous period
 Durée d'éclairage
 Brandtijd
 Tiempo de iluminación
 Tempo di durata
 Perioada de iluminare
 Valaistusaika
 Czas świecenia

LENNON



R52176101

Kunststoff
plastic
plastique
kunststof
plástico
plastica
plastic
muovi
plastik

01 Weiß · white
02 Schwarz · black

Incl. 1 x SMD-LED, 2 W
200 lm, 3.000 K

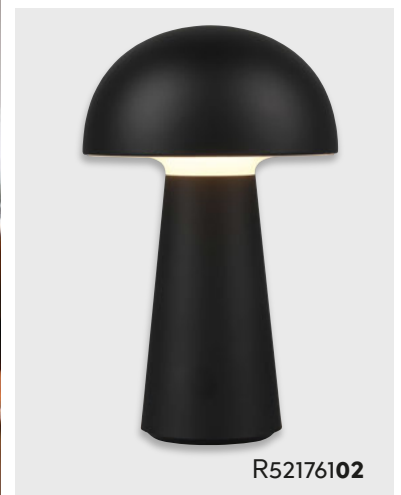
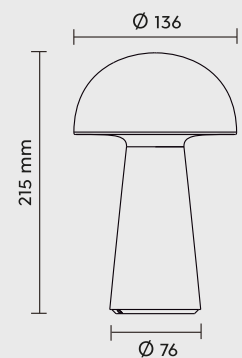

R52176102



Akkubetrieb
Rechargeable battery operated
Fonctionnement sur batteries rechargeable
Oplaadbare accu
Batería recargable
Batteria Ricaricabile
Operabil prin baterie reincarcabila
Ladattava akku
Akumulator zasilany baterijnie



USB Anschluss mit Ladefunktion
Recharging USB connection
Entrée USB de rechargement
Opladende USB aansluiting
Conexión USB de recarga
Connessione USB di ricarica
Conexiune USB reîncărcare
Lataaminen USB-liitäntä
Ładowania USB połączenie



BOLO

Kunststoff
plastic
plastique
kunststof
plástico
plastica
plastic
muovi
plastik

01 Weiß · white

Excl. 1 x E27, max. 23 W

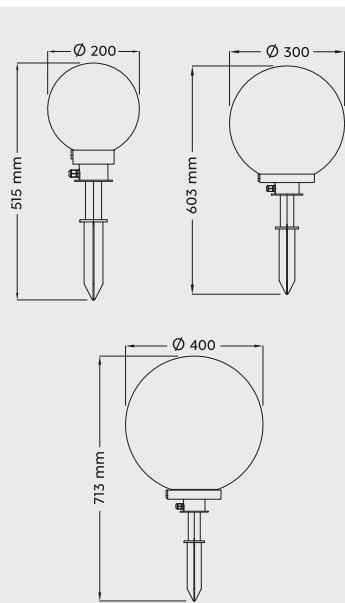

R57043001



R57042001



R57044001

Empfohlen:
recommended:

LED E27, 10 W
806 lm, 3.000 K



R988-90







Sonne Tanken!

Solarleuchten nutzen ausschließlich die Kraft der Sonne um Licht zu erzeugen. Dabei sind sie extrem umwelt-schonend, sparsam und gleichermaßen praktisch, da sie weder Steckdosen noch einen Anschluss ans Stromnetz benötigen. In Kombination mit moderner LED-Technik bieten Solarleuchten ideales Licht für Haus und Garten.

Soak up the sun!

Solar lamps exclusively use the power of the sun to generate light. At the same time they are extremely environmentally friendly and economical as well as practical, as they need neither sockets nor a connection to the mains supply. In combination with modern LED technology, solar lamps provide an ideal light for home and garden.

Faites le plein de soleil !

Les lampes solaires utilisent exclusivement l'énergie du soleil pour générer de la lumière. En même temps, elles sont extrêmement écologiques, économiques et tout aussi pratiques, car elles ne nécessitent ni prise de courant ni raccordement au réseau électrique. En combinaison avec la technologie LED moderne, les lampes solaires fournissent une lumière idéale pour la maison et le jardin.

Doe zon op!

Zonnelampen maken uitsluitend gebruik van de kracht van de zon om licht te produceren. Daarbij zijn ze extreem milieuvriendelijk, zuinig en in gelijke mate praktisch, omdat ze noch een stopcontact noch een aansluiting op het stroomnet nodig hebben. In combinatie met moderne ledtechniek bieden z onnelampen ideaal licht voor huis en tuin.

¡Disfrute del sol!

Las luces solares usan exclusivamente la energía del sol para generar luz. Al mismo tiempo, son extremadamente ecológicas, económicas e igualmente prácticas, y no necesitan ni enchufes ni conexión a la corriente. En combinación con las modernas técnicas LED, las luces solares ofrecen una luz ideal para la casa y el jardín.



Prendete un po' di sole!

Le lampade solari utilizzano esclusivamente la potenza del sole per generare luce. Allo stesso tempo sono estremamente rispettose dell'ambiente, economiche e pratiche in quanto non richiedono né presa di corrente, né un collegamento alla rete elettrica. In combinazione con la moderna tecnologia LED, le lampade solari forniscono una luce ideale per la casa e il giardino.

Alimentați cu soare!

Lămpile solare se folosesc în exclusivitate de energia soarelui pentru a genera lumină. În acest context sunt extrem de ecologice, economice și practice în același timp, deoarece nu necesită nici prize și nici conectarea la o rețea electrică. În combinație cu tehnologia modernă LED, lămpile solare oferă lumina ideală pentru casă și grădină.

Ajattele aurinkoa!

Aurinkovalaisimet käyttävät auringon energiaa valon tuottamiseen. Samalla ne ovat erittäin ympäristöystävällisiä, taloudellisia ja myös käytännöllisiä, koska ne eivät vaadi pistorasioita tai liitäntää sähköverkkoon. Yhdessä modernin LED-tekniikan kanssa aurinkovalaisimet tarjoavat ihanteellisen valaistuksen kotiin ja puutarhaan.

Nałapać energii słonecznej!

Lampy solarne wykorzystują moc słońca do generowania światła. Są one przy tym niezwykle przyjazne dla środowiska, ekonomiczne i jednocześnie praktyczne, ponieważ nie wymagają gniazd ani podłączenia do sieci elektrycznej. W połączeniu z nowoczesną technologią LED lampy solarne zapewniają idealne oświetlenie domu i ogrodu.

POSADAS

Kunststoff
 plastic
 plastique
 kunststof
 plástico
 plastica
 plastic
 muovi
 plastik

42 Anthrazit · anthracite

Incl. 1 x SMD-LED, 4,5 W
 290 lm, 3.000 K



R22251142



R42251142

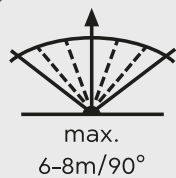
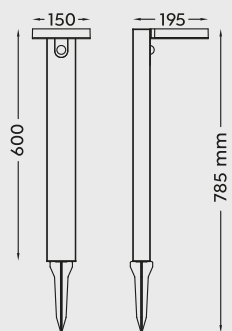
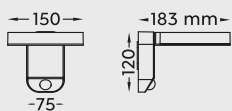

Ladezeit
 Charging time
 Temps de charge
 Oplaadtijd
 Tiempo de carga
 Tempo di carica
 Timp de incarcare
 Latausaika
 Czas ładowania



Leuchtdauer
 Luminous period
 Durée d'éclairage
 Brandtijd
 Tiempo de iluminación
 Tempo di durata
 Perioada de iluminare
 Valaistus aika
 Czas świecenia





ESQUEL

Kunststoff
 plastic
 plastique
 kunststof
 plástico
 plastica
 plastic
 muovi
 plastik

42 Anthrazit · anthracite

Incl. 1 x SMD-LED, 4,5 W
 290 lm, 3.000 K

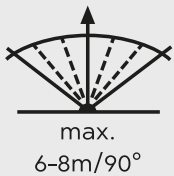
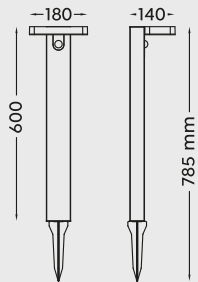
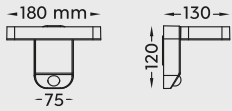

R22261142



R42261142



Ladezeit
 Charging time
 Temps de charge
 Oplaadtijd
 Tiempo de carga
 Tempo di carica
 Timp de incarcare
 Latausaika
 Czas ładowania



Leuchtdauer
 Luminous period
 Durée d'éclairage
 Brandtijd
 Tiempo de iluminación
 Tempo di durata
 Perioada de iluminare
 Valaistusaika
 Czas świecenia



Kunststoff
 plastic
 plastique
 kunststof
 plástico
 plastica
 plastic
 muovi
 plastik

42 Anthrazit · anthracite

Incl. 1 x SMD-LED, 5 W
 200 lm, 3.000 K

R22241142



Incl. 1 x SMD-LED, 4,8 W
 340 lm, 3.000 K

R22281142

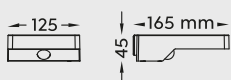

MENDOZA

R22241142



FOMOSA

R22281142



max.
 5-8m/90°



Ladezeit
 Charging time
 Temps de charge
 Oplaadtijd
 Tiempo de carga
 Tempo di carica
 Timp de încarcare
 Latausaika
 Czas ładowania



SALTA

Metall, Acryl
metal, acryl
metale, acryl
metaal, acryl
metal, acrílico
metallo, acrilico
metal, acrilic
metalli, akryyli
metal, akryl

07 Nickel matt · nickel mat

42 Anthrazit · anthracite

Incl. 1 x SMD-LED, 3 W
165 lm, 3.000 K



R22231107

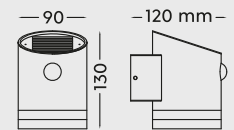

R22231142



Leuchtdauer
Luminous period
Durée d'éclairage
Brandtijd
Tiempo de iluminación
Tempo di durata
Perioada de iluminare
Valaistus aika
Czas świecenia

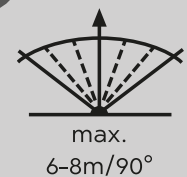

MINEROS

Kunststoff
plastic
plastique
kunststof
plástico
plastica
plastic
muovi
plastik

01 Weiß · white

11 Grau · grey

Incl. SMD-LED, 0,02 W



R55256101



R55256901

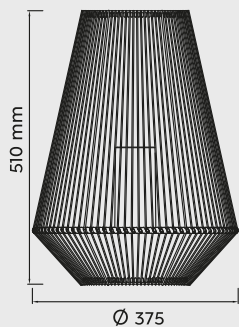
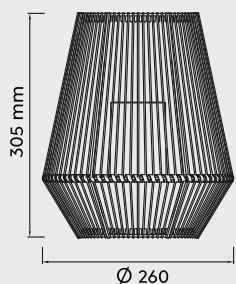

R55256911



R55256111



Ladezeit
Charging time
Temps de charge
Oplaadtijd
Tiempo de carga
Tempo di carica
Timp de incarcare
Latausaika
Czas ładowania



Leuchtdauer
Luminous period
Durée d'éclairage
Brandtijd
Tiempo de iluminación
Tempo di durata
Perioada de iluminare
Valaistus aika
Czas świecenia



Dämmerungssensor
Dusk sensor
Détecteur de crépuscule
Schemeringsensor
Sensor de oscuridad
Sensore crepuscolare
Sensor de lumina/amurg
Hämärätunnistin
Czujnik zmierzchowy



Flammen-Effekt
Flame effect
Effet de flamme
Vlammeneffect
Efecto de llamas
Effetto fiamma
Efect de flacăără
Liekkitehoste
Efekt płomienia

VINTO

Kunststoff
 plastic
 plastique
 kunststof
 plástico
 plastica
 plastic
 muovi
 plastik

44 Beige · fawn

Incl. SMD-LED, 0,1 W
R55276144



Incl. SMD-LED, 0,2 W
R55276944

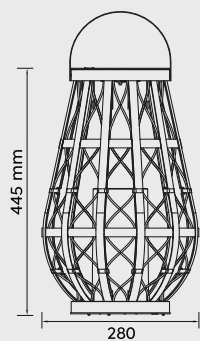
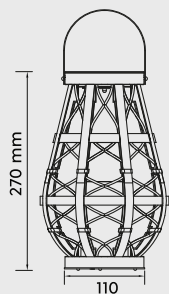

R55276144



R55276944



Ladezeit
 Charging time
 Temps de charge
 Oplaaftijd
 Tiempo de carga
 Tempo di carica
 Timp de incarcare
 Latausaika
 Czas ładowania



Leuchtdauer
 Luminous period
 Durée d'éclairage
 Brandtijd
 Tiempo de iluminación
 Tempo di durata
 Perioada de iluminare
 Valaistusaika
 Czas świecenia



MONTERO

Metall
metal
metale
metaal
metal
metallo
metal
metalli
metal

31 Weiß matt · white mat

88 Silber antik · antique silver

Incl. SMD-LED, 0,1 W

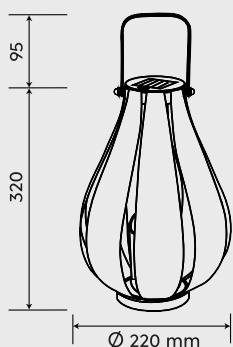

R55266131



R55266188

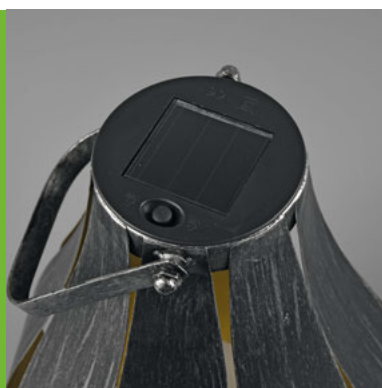

Ladezeit
Charging time
Temps de charge
Oplaaadtijd
Tiempo de carga
Tempo di carica
Timp de incarcare
Latausaika
Czas ładowania



Leuchtdauer
Luminous period
Durée d'éclairage
Brandtijd
Tiempo de iluminación
Tempo di durata
Perioada de iluminare
Valaistus aika
Czas świecenia

ARBIETO

Kunststoff
plastic
plastique
kunststof
plástico
plastica
plastic
muovi
plastik

42 Anthrazit · anthracite

Incl. SMD-LED, 0,02 W

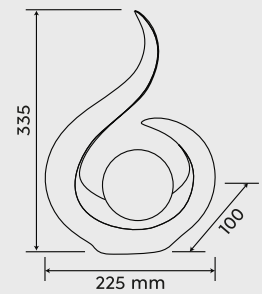

R55296142



Dämmerungssensor
Dusk sensor
Décteur de crépuscule
Schemeringsensor
Sensor de oscuridad
Sensore crepuscolare
Sensor de lumina/amurg
Hämärätunnistin
Czujnik zmierzchowy



Flammen-Effekt
Flame effect
Effet de flamme
Vlammeneffect
Efecto de llamas
Effetto fiamma
Efect de flacără
Liekkitehoste
Efekt płomienia



CAMIRI

Metall
metal
metale
metaal
metal
metallo
metal
metalli
metal

62 Kupfer antik · antique copper

88 Silber antik · antique silver

Incl. SMD-LED, 0,02 W

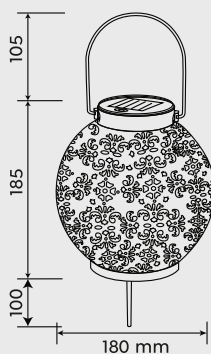

R55286188



R55286162



Ladezeit
Charging time
Temps de charge
Oplaadtijd
Tiempo de carga
Tempo di carica
Timp de incarcare
Latausaika
Czas ładowania



Leuchtdauer
Luminous period
Durée d'éclairage
Brandtijd
Tiempo de iluminación
Tempo di durata
Perioada de iluminare
Valaistusaika
Czas świecenia



R55316132

Metall
metal
metale
metaal
metal
metallo
metal
metalli
metal

32 Schwarz matt · black mat

Incl. SMD-LED, 0,01 W

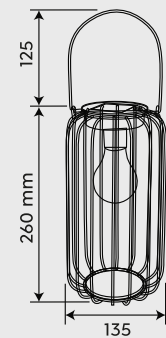

Dämmerungssensor
Dusk sensor
Décteur de crépuscule
Schemeringsensor
Sensor de oscuridad
Sensore crepuscolare
Sensor de lumina/amurg
Hämärätunnistin
Czujnik zmierzchowy



Flammen-Effekt
Flame effect
Effet de flamme
Vlammeneffect
Efecto de llamas
Effetto fiamma
Efect de flacără
Liekkitehoste
Efekt płomienia



Kunststoff
 plastic
 plastique
 kunststof
 plástico
 plastica
 plastic
 muovi
 plastik

26 Braun · brown
32 Schwarz matt · black mat

Incl. SMD-LED, 0,1 W
R55196126



Incl. SMD-LED, 0,2 W
R55146132



CARMELO
 R55196126

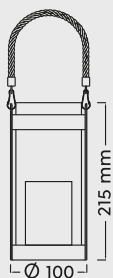

MINAS
 R55146132



Flammen-Effekt
 Flame effect
 Effet de flamme
 Vlammeffect
 Efecto de llamas
 Effetto fiamma
 Efect de flacără
 Liekkitehoste
 Efect płomienia



R55136132

Metall, Kunststoff
 metal, plastic
 metale, plastique
 metaal, kunststof
 metal, plástico
 metallo, plastica
 metal, plastic
 metalli, muovi
 metal, plastik

32 Schwarz matt · black mat

Incl. SMD-LED, 0,2 W

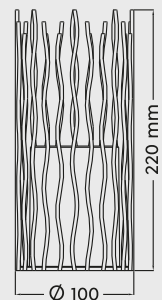

Ladezeit
 Charging time
 Temps de charge
 Oplaadtijd
 Tiempo de carga
 Tempo di carica
 Timp de incarcare
 Latausaika
 Czas ładowania



Leuchtdauer
 Luminous period
 Durée d'éclairage
 Brandtijd
 Tiempo de iluminación
 Tempo di durata
 Perioada de iluminare
 Valaistusaika
 Czas świecenia

Kunststoff
plastic
plastique
kunststof
plástico
plastica
plastic
muovi
plastik

32 Schwarz matt · black mat

Incl. SMD-LED, 0,24 W



PARRAL

R55166132

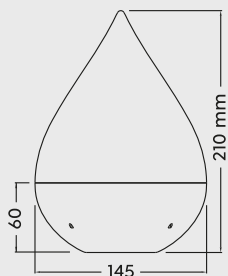
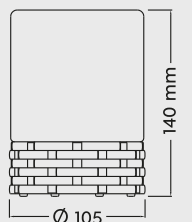

CALDERA

R55156132



Flammen-Effekt
Flame effect
Effet de flamme
Vlammeneffect
Efecto de llamas
Effetto fiamma
Efect de flacără
Liekkitehoste
Efekt plomienia





R55176132

Metall, Kunststoff
metal, plastic
metale, plastique
metaal, kunststof
metal, plástico
metallo, plastica
metal, plastic
metalli, muovi
metal, plastik

32 Schwarz matt · black mat

Incl. SMD-LED, 0,1 W

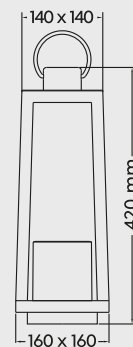

Ladezeit
Charging time
Temps de charge
Oplaadtijd
Tiempo de carga
Tempo di carica
Timp de incarcare
Latausaika
Czas ładowania



Leuchtdauer
Luminous period
Durée d'éclairage
Brandtijd
Tiempo de iluminación
Tempo di durata
Perioada de iluminare
Valaistusaika
Czas świecenia

MELO

Kunststoff
plastic
plastique
kunststof
plástico
plastica
plastic
muovi
plastik

01 Weiß · white

Incl. 1 x RGBW-LED, 0,5 W

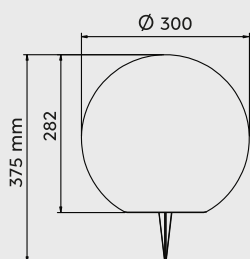
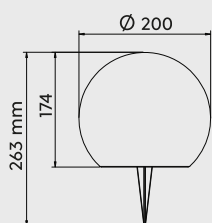

R55326901

R55326101



RGBW Farbwechsler
RGBW Colorchanging
Changement de couleur RGBW
RGBW Kleurverandering
Cambio de color RGBW
Cambia colore RGBW
Schimbator de culoare RGBW
Värvaihto RGB
Zmieniający kolor RGBW



Ladezeit
Charging time
Temps de charge
Oplaadtijd
Tiempo de carga
Tempo di carica
Timp de incarcare
Latausaika
Czas ładowania



Leuchtdauer
Luminous period
Durée d'éclairage
Brandtijd
Tiempo de iluminación
Tempo di durata
Perioada de iluminare
Valaistusaika
Czas świecenia

Produkteigenschaften · Features

Caractéristiques · Kenmerken · Acabados ·
Caratteristiche · Caracteristici · Ominaisuudet · Cechy



Schalter · Switch

Interrupteur · Schakelaar · Interruptor ·
Interruttore · Intrerupator · Kytkin ·
Przełącznik



Fernbedienung · Remote control

Commande à distance · Afstandsbediening ·
Mando a distancia · Comando a distanza ·
Telecomanda · Kauko-ohjain · Pilot



Integrierter Dimmer · Integrated dimmer

Variateur intégré · Geïntegreerde dimmer ·
Regulador integrado · Dimmer integrato ·
Variator de lumina integrat · Integroitu himmennin ·
Wbudowany ściemniacz



RGBW Farbwechsler · RGBW Colorchanging

Changement de couleur RGBW ·
RGBW Kleurverandering · Cambio de color RGBW ·
Cambia colore RGBW · Schimbator de culoare
RGBW · Värvivaihto RGB · Zmieniający kolor RGBW



RGB Farbwechsler · RGB Colorchanging

Changement de couleur RGB ·
RGB Kleurverandering · Cambio de color RGB ·
Cambia colore RGB · Schimbator de culoare RGB ·
Värvivaihto RGB · Zmieniający kolor RGB



Schwenkbar · Tilttable

Pivotant · Draaibaar · Pivotante ·
Girevole · Pivotant · Suunnattava · Skräpny



Steckdose · Plug

Prise · Stekker · Enchufe · Spina ·
Priza · Katkaisin · Gniazdko



Bewegungssensor · Motion sensor

Détecteur de mouvement · Bewegungssensor ·
Sensor de movimiento · Sensore di movimento ·
Senzor de mișcare · Liiketunnistin · Czujnik ruchu



Dämmerungssensor · Dusk sensor

Détecteur de crépuscule · Schemeringsensor ·
Sensor de oscuridad · Sensore crepuscolare ·
Senzor de lumina/amurg · Hämärätunnistin ·
Czujnik zmierzchowy



4 fach TOUCH · 4 level Touch function

Interrupteur tactile 4 niveaux ·
Touch schakelaar 4 niveaus · Función Táctil 4 nivel ·
Interruttore touch 4 livelli · Intrerupator tactil
4 nivele · Kosketuskäyttöinen 4 taso ·
Funkcja dotykowa 4 poziomy



Lichtfarbe stufenlos einstellbar ·

Light color infinitely variable ·
Couleur de lumière infiniment variable ·
Lichtkleur traploos instelbaar · Color de luz
infinitamente variable · Colore della luce
infinitamente variabile · Culoare lumină infinit
variabilă · Valon väri portaattomasti ·
Jasny kolor bezstopniowo



Up and down Beleuchtung ·

Up and Down lighting ·
Point lumineux en haut et en bas · Lichtpunt boven
en onder · Luz de arriba y abajo · Luce su e giù ·
Sus și în jos lumina · Ylös ja alas valoa ·
W górę iw dół światło



Ohne Leuchtmittel · Lamp(s) excluded

Sans ampoule(s) · Zonder lichtbron(nen) ·
Sin bombilla(s) · Lampadina Esclusa · Fara bec (s) ·
Ilman polttimo (s) · Bez żarówki (s)



Timer · Timer

Minuterie · Timer · Temporizador · Timer ·
Temporizator · Ajastin · Timer



Helligkeit einstellbar · Adjustable light level

Niveau d'éclairage ajustable · Instelbaar
lichtniveau · Nivel de luz ajustable · Livello di luce
regolabile · Nivelul de lumina reglabil · Säädettävä
valo taso · Regulowana jasność światła



Bluetooth Lautsprecher ·

Blouetooth loudspeaker ·
Haut-parleur bluetooth · Bluetooth luidspreker ·
Altavoz de bluetooth · Altoparlante bluetooth ·
Difuzor Bluetooth · Bluetooth-kaiutin ·
Głośnik Bluetooth



USB Anschluss · USB connection

Entrée USB · USB aansluiting · Conexión USB ·
Connessione USB · Conexiune USB ·
USB-liitäntä · Połączenie USB



USB Anschluss mit Ladefunktion ·

Recharging USB connection ·
Entrée USB de rechargement · Opladende USB
aansluiting · Conexión USB de recarga ·
Connessione USB di ricarica · Conexiune USB
reîncărcare · Lataaminen USB-liitäntä ·
ładowania USB połączenie



Solar · Solar
Solaire · Solair · Solar · Solare ·
Solar · Aurinkokenno · Solar



Memory Funktion · Memory function
fonction mémoire · Geheugen functie ·
Función de memoria · Funzione memorizzazione ·
functia memorie · Muistitoiminto · Funkcja pamięci



Akkubetrieb · Rechargeable battery operated
Fonctionnement sur batteries rechargeable ·
Oplaadbare accu · Batería recargable ·
Batteria Ricaricabile · Operabil prin baterie
reincarabila · Ladattava akku ·
Akumulator zasilany bateryjnje



Ladezeit · Charging time
Temps de charge · Oplaatijd · Tiempo de carga ·
Tempo di carica · Timp de incarcare · Latausaika ·
Czas ładowania



Leuchtdauer · Luminous period
Durée d'éclairage · Brandtijd · Tiempo de
iluminación · Tempo di durata · Perioada de
iluminare · Valaistusaika · Czas świecenia



Flammen-Effekt · Flame effect
Effet de flamme · Vlammeneffect · Efecto de
llamas · Effetto fiamma · Efect de flacără ·
Liekkitehoste · Efekt płomienia



Abstrahlwinkel · Emission angle
Angle de rayonnement · Uitstraalhoek ·
Ángulo de emisión · Angolo di emissione ·
Unghiul de emisii · Säteilykulma · Kąt emisji



Belastbarkeit · Resilience
Limite de charge · Belastbaarheid · Resistencia ·
Resistenza · Rezistența la solicitare ·
Kuormitettavuus · Nośność



Farben & Materialien · Colours and materials

Couleurs et matériaux · Kleuren en materialen · Colores y materiales · Colori e materiali ·
Culori si materiale · Värit ja materiaalit · Kolory i materiały

01 weiß · white

blanc · wit · blanco · bianco · alb · valkoinen · biały

02 schwarz · black

noir · zwart · negro · nero · negru · musta · czarny

07 Nickel matt · nickel mat

nickel mat · nikkel mat · níquel mate · nichel opaco ·
nichel mat · harjattu teräs · nikiel mat

11 grau · grey

gris · grijs · gris · grigio · gri · harmaa ·
popielaty · gri

24 rostfarbig · rusty

rouille · roestkleur · óxido · ruggine · ruginiu ·
rustiikki · miedź

26 braun · brown

brun · bruin · marron · marrone · maro ·
ruskea · brązowy

28 rostfarbig antik · antique rust

rouille antique · roestkleur antiek · oxido ·
ruggine anticato · ruginiu antic · rustiikki ·
antyczny rdzawy

30 holzfarbig · wood coloured

couleur bois · houtkleur · color maderá · colore di legno ·
culoare lemn · puunvärinen · kolor drewna · ahşap renk

31 weiß matt · white mat

blanc mat · wit mat · estera blanca · bianco opaco ·
alb mat · valkoinen matto · biały mat

32 schwarz matt · black mat

noir mat · mat zwart · estera negra · nero opaco ·
negru mat · musta matto · czarny mat

42 anthrazit · anthracite

antracite · antraciet · antracita · antracite · antracit ·
antrasiitti · antracyt

44 Beige · fawn

beige · beige · beige · beige · bej · beige · bez

62 Kupfer antik · antique copper

cuivre ancien · antiek koper · cobre antiguo ·
rame antico · cupru antic · antiikki kupari ·
antyczne miedzi · antik bakır

78 betonfarbig · concrete look

couleur beton · beton kleur · color concreto ·
calcestruzzo · culoare beton · konkreettisia väri ·
konkretny kolor

86 zinkfarbig · zinc-colored

couleur zinc · zink kleur · color zinc · color zinco ·
culoarea Zincului · sinkki · kolor cynkowy

87 titanfarbig · titan

titane · titaan · titán · titano · titaniu ·
titaani · tytanowy

88 silber antik · antique silver

argent antique · antiek zilver · plateado antiquo ·
argento anticato · argint antic · antiikkihopea ·
antyczne srebro

Seite Page	Artikel-Nr. Product No.	EAN-Nummer EAN-Number
12	273360142	4017807492750
12	473360442	4017807492767
12	473369442	4017807492781
14	226260142	4017807492545
14	426260142	4017807492576
14	526260142	4017807492569
16	222360142	4017807384321
16	422360142	4017807384338
16	522360142	4017807384345
18	226160142	4017807490442
18	426160142	4017807490466
18	526160142	4017807490459
20	220760142	4017807259063
20	420760142	4017807259087
20	520760142	4017807259100
22	221760142	4017807303551
22	421760142	4017807303582
22	521760142	4017807303575
23	221769142	4017807303568
24	221660242	4017807291544
24	221669242	4017807297614
24	421660242	4017807291551
24	521660242	4017807291568
26	220360142	4017807241648
26	420360142	4017807241655
26	520360142	4017807241662
28	221260142	4017807281484
28	421260142	4017807281507
28	521260142	4017807281521
29	221269142	4017807279665
30	222060142	4017807337624
30	422060142	4017807337648
30	522060142	4017807337631
32	222160142	4017807377323
32	422160142	4017807377347
32	522160142	4017807377330
33	422167142	4017807445398
34	223669142	4017807408492
34	423669142	4017807408515
34	523669142	4017807408508
36	221169142	4017807279290
36	421169142	4017807279306
36	521169142	4017807279313
38	221160142	4017807302004
38	421160142	4017807351583
38	521160142	4017807351590
40	225369142	4017807481525
40	425369142	4017807481570
40	525369142	4017807481556
42	225360142	4017807481501
42	425360142	4017807481563
42	525360142	4017807481549

Seite Page	Artikel-Nr. Product No.	EAN-Nummer EAN-Number
44	226369142	4017807492354
44	426369142	4017807492392
44	526369142	4017807492378
46	226360142	4017807492347
46	426360142	4017807492385
46	526360142	4017807492361
48	220260142	4017807241617
48	420260142	4017807241624
48	520260142	4017807241631
50	204260242	4017807453171
50	204269242	4017807453195
50	404260142	4017807453232
50	504260142	4017807453218
52	206060142	4017807490480
52	406060142	4017807490503
52	506060142	4017807490497
54	228460242	4017807284164
55	221460142	4017807490473
56	229360242	4017807242164
56	229360287	4017807242171
58	227560231	4017807337570
58	227560242	4017807337594
58	227560287	4017807346138
58	227660231	4017807337600
58	227660242	4017807337617
58	227660287	4017807346145
59	226460231	4017807415605
59	226460242	4017807415612
59	226460287	4017807415629
60	226960231	4017807382259
60	226960242	4017807382266
60	226960287	4017807382273
61	226560242	4017807408539
62	226860231	4017807382822
62	226860242	4017807382839
62	226860287	4017807387971
64	227860231	4017807298604
64	227860242	4017807298611
65	228560242	4017807356984
66	220960142	4017807259308
66	220960187	4017807259322
67	220969142	4017807259315
67	220969187	4017807259339
68	228760101	4017807279269
68	228760142	4017807279276
69	620160142	4017807274905
70	226660242	4017807388893
70	226669242	4017807388817
71	227360142	4017807369229
72	228260101	4017807279528
72	228260142	4017807279535
74	229160142	4017807242126

Seite Page	Artikel-Nr. Product No.	EAN-Nummer EAN-Number	Seite Page	Artikel-Nr. Product No.	EAN-Nummer EAN-Number
75	227160242	4017807369335	107	227460131	4017807369205
76	222969131	4017807491296	107	227460188	4017807369212
76	222969142	4017807491272	108	207269124	4017807492613
76	222969231	4017807491357	108	207269131	4017807492620
76	222969242	4017807491371	108	207269142	4017807492637
78	222960131	4017807491234	110	207360142	4017807492675
78	222960142	4017807491258	110	407360142	4017807492729
78	222960231	4017807491319	110	507360142	4017807492705
78	222960242	4017807491326	112	209660130	4017807492798
80	228360101	4017807279603	112	409660130	4017807492828
80	228360142	4017807279610	112	509660130	4017807492804
82	227760142	4017807303537	114	201860130	4017807492859
83	228669142	4017807356656	114	401860130	4017807492897
84	228060101	4017807281552	114	501860130	4017807492873
84	228060142	4017807281569	116	201860142	4017807433210
85	228960101	4017807259124	116	201860242	4017807442410
85	228960142	4017807259131	116	401860142	4017807433258
86	227260142	4017807369236	116	501860142	4017807433234
87	222860142	4017807492590	116	601860242	4017807442397
88	676960131	4017807453393	118	201860186	4017807433227
88	676960142	4017807453416	118	201860286	4017807442427
90	676160224	4017807453430	118	401860186	4017807433265
90	676160278	4017807453447	118	501860186	4017807433241
92	222260124	4017807410594	118	601860286	4017807442403
92	222260224	4017807410587	120	204160142	4017807413946
92	422260124	4017807410570	120	404160142	4017807413960
92	522260124	4017807410563	120	504160142	4017807413991
94	222260142	4017807382570	121	204160131	4017807492408
94	222260242	4017807382587	122	204160124	4017807413939
94	422260142	4017807382600	122	404160124	4017807413953
94	522260142	4017807382594	122	504160124	4017807413977
96	224060142	4017807434330	124	204169124	4017807492446
96	224060242	4017807434347	124	204169131	4017807492422
96	424060142	4017807434361	124	204169142	4017807492460
96	524060142	4017807434354	126	202360142	4017807442069
97	424067142	4017807445404	126	402360142	4017807453119
98	220060142	4017807241501	126	502360142	4017807453096
98	220060242	4017807241525	128	202360124	4017807449891
98	420060142	4017807241792	128	402360124	4017807453102
98	520060142	4017807241563	128	502360124	4017807453072
100	220060187	4017807241518	130	201760124	4017807442021
100	220060287	4017807241532	130	201760142	4017807445411
100	420060187	4017807241808	130	201760186	4017807442038
100	520060187	4017807241570	132	301760124	4017807447309
102	221560142	4017807282375	132	301760142	4017807447323
102	421560142	4017807282399	132	301760186	4017807447354
102	421560242	4017807282405	134	201960124	4017807442045
104	204960142	4017807445169	134	201960142	4017807442052
104	404960142	4017807445176	135	201360124	4017807442007
106	220160142	4017807241587	135	201360142	4017807442014
106	420160142	4017807241594	136	221967128	4017807331196
106	520160142	4017807241600	136	221969128	4017807331219

Seite Page	Artikel-Nr. Product No.	EAN-Nummer EAN-Number
137	202760124	4017807445589
137	202760142	4017807449884
137	202760178	4017807445602
138	251060131	4017807491395
138	251060142	4017807491401
139	251160131	4017807491432
139	251160142	4017807491456
140	821660107	4017807453287
140	821669107	4017807453300
141	821660207	4017807453348
141	821669207	4017807453379
142	551753001	4017807407440
142	551754001	4017807407457
145	800260142	4017807453133
145	800260342	4017807453157
146	9961-11	4017807305777
146	9962-11	4017807305784
146	9963-11	4017807305791
147	9964-42	4017807445299
148	9960-07	4017807259360
149	9965-32	4017807472349
152	R28211107	4017807370898
152	R28212107	4017807370973
154	R28222631	4017807408324
154	R28222632	4017807411775
155	R28232631	4017807408317
155	R28232632	4017807411768
156	R28200642	4017807296952
157	R22052142	4017807490428
157	R22062142	4017807490435
158	R22151131	4017807453492
158	R22151142	4017807453546
158	R62151131	4017807405941
158	R62151142	4017807405989
160	R60501031	4017807405873
160	R60501042	4017807405910
160	R60502031	4017807405927
160	R60502042	4017807405934
164	R45101101	4017807500295
164	R45101901	4017807500301
164	R55101101	4017807500271
166	R55060101	4017807430578
167	R55086101	4017807444421
168	R57080101	4017807407556
169	R57090101	4017807407563
170	R55096101	4017807492200
172	R57010101	4017807279948
172	R57020101	4017807279955
173	R57051101	4017807382518
173	R57071101	4017807325348
174	R42096142	4017807467116
174	R52096142	4017807467031

Seite Page	Artikel-Nr. Product No.	EAN-Nummer EAN-Number
175	R52176101	4017807496314
175	R52176102	4017807496338
176	R57042001	4017807282801
176	R57043001	4017807282818
176	R57044001	4017807282825
180	R22251142	4017807452686
180	R42251142	4017807452709
182	R22261142	4017807452723
182	R42261142	4017807452730
184	R22241142	4017807452662
184	R22281142	4017807452754
185	R22231107	4017807458220
185	R22231142	4017807452648
186	R55256101	4017807492040
186	R55256111	4017807492064
186	R55256901	4017807492088
186	R55256911	4017807492095
188	R55276144	4017807492002
188	R55276944	4017807492026
190	R55296142	4017807492286
191	R55266131	4017807492309
191	R55266188	4017807492323
192	R55316132	4017807492262
193	R55286162	4017807492224
193	R55286188	4017807492248
194	R55146132	4017807452792
194	R55196126	4017807452907
195	R55136132	4017807452778
196	R55156132	4017807452815
196	R55166132	4017807452822
197	R55176132	4017807452853
198	R55326101	4017807492101
198	R55326901	4017807492125



TRIO Leuchten GmbH

Gut Nierhof 17
D-59757 Arnsberg

T +49 2931 9666-0
F +49 2931 9666-57

info@trio-leuchten.de
www.trio-leuchten.de



Reality Leuchten GmbH

Gut Nierhof 17
D-59757 Arnsberg

T +49 2931 9666-99
F +49 2931 9666-98

info@reality-leuchten.de
www.reality-leuchten.de

NIEDERSACHEN, SCHLESWIG-HOLSTEIN, HAMBURG, BREMEN

Jens Gebers

T +49 170 1615227
jens.gebers@trio-leuchten.de

BERLIN, BRANDENBURG, MECKL.-VORPOMMERN, SACHSEN, SACHSEN ANHALT, THÜRINGEN

Jörg Bumke

T +49 160 7406860
joerg.bumke@trio-leuchten.de

NORDRHEIN-WESTFALEN

Antonio Capizzi

T +49 172 2598392
capizziantonio@aol.com

SAARLAND, RHEINLAND-PFALZ, HESSEN

Christian Teller

T +49 171 4521820
christian.teller@trio-leuchten.de

ÖSTERREICH

Wolfgang Melich

T +43 660 5161228
wolfgang.melich@trio-leuchten.de

BADEN WÜRTTEMBERG

Antonio De Simone

T +49 151 58555222
antonio.desimone@trio-leuchten.de

SCHWEIZ

Andreas Huber

T +41 76 316 22 89
andreas.huber@trio-leuchten.ch

BAYERN, HESSEN

Martin Kluge

T +49 171 7300330
martin.kluge@trio-leuchten.de

TRIO International GmbH

Gut Nierhof 17
D-59757 Arnsberg
T +49 2931 9666-587
F +49 2931 9666-56
info@trio-lighting.com
www.trio-lighting.com

FRANCE

Stéphane Papierny

Directeur Commercial France
info.france@trio-lighting.com

Jean Philippe Bailly

info.france@trio-lighting.com
Agent exclusif pour les départements
60, 75001-75004, 75008-75010,
75017-75019, 92, 93, 95

Jean Barel

info.france@trio-lighting.com
Agent exclusif pour les départements
09, 12, 15, 16, 19, 23, 24, 31, 32, 33, 40,
46, 47, 64, 65, 81, 82 et 87

Nina & Richard Lecoiffier

info.france@trio-lighting.com
Agents exclusifs pour les départements
27, 28, 76

Antoine Masu

info.france@trio-lighting.com
Agent exclusif pour les départements
2a et 2b

Christophe Meulien

info.france@trio-lighting.com
Agent exclusif pour les départements
04, 05, 06, 11, 13, 30, 34, 66, 83 et 84

Stéphane Riebel

info.france@trio-lighting.com
Agent exclusif pour les départements
18, 45, 58, 75005-75007, 75011-75016,
75020, 77, 78, 89, 91, 94

Michel Salamand

info.france@trio-lighting.com
Agent exclusif pour les départements
14, 17, 22, 29, 35, 36, 37, 41, 44, 49, 50,
53, 56, 61, 72, 79, 85 et 86

Vincent Zaepffel

info.france@trio-lighting.com
Commercial pour les départements
02, 08, 10, 25, 51, 52, 54, 55, 57, 59, 62,
67, 68, 70, 80, 88 et 90

Sullivan Nicolas

info.france@trio-lighting.com
Agent exclusif pour les départements
01, 03, 07, 21, 26, 38, 39, 42, 43, 48, 63,
69, 71, 73 et 74

NEDERLAND

Karl Stok / Bas Martin

info.nederland@trio-lighting.com

BELGIUM/BELGIQUE

Yves van den Berghe

info.belgium@trio-lighting.com

ITALIA

TRIO Lighting Italia s.r.l

Via Padre Masciadri, 2 H
IT-22066 Mariano Comense (CO)
T +39 317 477 55
F +39 313 551 560
commerciale@trio-lighting.com

ESPAÑA

TRIO Lighting Ibèrica SL

C/ Can Lietget n°9 nave9
Pol. Ind. Can Roqueta
08206 Sabadell
T +34 9 35 45 86 30
F +34 9 33 96 45 48
info.iberica@trio-lighting.com

SUOMI

TRIO Lighting Scandinavia Oy

Malmin raitti, rappu 17 B
00700 Helsinki
T +358 10 23 13 390
F +358 10 23 13 399
info.scandinavia@trio-lighting.com
Our Scandinavian organisation represents TRIO
also in DENMARK, SWEDEN, NORWAY, ESTONIA,
LATVIA and LITHUANIA

GREAT BRITAIN

TRIO Lighting UK Ltd.

Unit 5, Hemmells Park Hemmells, Laindon
Essex
SS1s 6GF
T +44 12 68 88 95 95
F +44 12 68 88 95 96
sales@triolightinguk.com

ROMANIA

Gina Ionita

info.romania@trio-lighting.com

TRIO Leuchten GmbH

Gut Nierhof 17
D-59757 Arnsberg
T +49 2931 9666-0
F +49 2931 9666-28
info@trio-leuchten.de
www.trio-leuchten.de

Reality Leuchten GmbH

Gut Nierhof 17
D-59757 Arnsberg
T +49 2931 9666-99
F +49 2931 9666-98
info@reality-leuchten.de
www.reality-leuchten.de

TRIO International GmbH

Gut Nierhof 17
D-59757 Arnsberg
T +49 2931 9666-587
F +49 2931 9666-56
info@trio-lighting.com
www.trio-lighting.com

 @trioleuchten

 /trioleuchten

 @trio.lighting

